

***GLASGOW
HISTORIC PRESERVATION
DESIGN GUIDELINES
2004***



Downtown Glasgow

Prepared for:

**Renaissance/Main Street Glasgow
126 East Public Square
P.O. Box 278
Glasgow, Kentucky 42142-0278**

Prepared by:

**Donna G. Logsdon
Logsdon & Logsdon Architects
5600 Hardyville Road
P.O. Box 10
Hardyville, Kentucky 42746-0010**

TABLE OF CONTENTS

ACKNOWLEDGMENTS	1
INTRODUCTION	2
WHY ESTABLISH DESIGN GUIDELINES?	3
THE SECRETARY OF THE INTERIOR'S STANDARDS FOR REHABILITATION	4
GLASGOW'S HISTORIC DISTRICTS:	
NATIONAL REGISTER VS. LOCAL HISTORIC DISTRICTS	5
LOCAL HISTORIC DISTRICT MAP	7
BOUNDARY DESCRIPTION	8
THE REVIEW PROCESS - CERTIFICATE OF APPROPRIATENESS	9
DESIGN GUIDELINES	14
OVERALL APPROACH AND POLICY	14
SITE AND SETTING	15
PARKING FACILITIES	15
LIGHTING	15
LANDSCAPING	16
ACCESSORY BUILDINGS	16
RECREATIONAL STRUCTURES	16
OUTBUILDINGS	16
FENCES	17
DRIVEWAYS	18
REHABILITATION	19
BUILDING USE	19
MAINTENANCE	19
FAÇADE MATERIALS	19
PAINT AND COLOR	20
STOREFRONTS	20
DOORS	22
WINDOWS	23
STORM WINDOWS	26
SHUTTERS	27
AWNINGS	28
STAIRCASES	29
SIDING AND TRIM	30
PORCHES/BALCONIES	30
FLOORS	33

TABLE OF CONTENTS – continued

REHABILITATION - continued

COLUMNS	33
RAILINGS	34
STAIRS.....	34
ENTRANCES	34
MASONRY.....	35
FOUNDATION WALLS.....	37
ROOFS.....	38
GUTTERS AND DOWNSPOUTS	40
CHIMNEYS.....	40
ARCHITECTURAL ORNAMENTATION	40
SIGNAGE.....	41
MURALS	45
NEW CONSTRUCTION	47
DEMOLITION AND RELOCATION.....	51
DEFINITIONS.....	52
PROCEDURAL	52
TECHNICAL	52
ARCHITECTURAL	55
APPENDIX A: BIBLIOGRAPHY.....	63
APPENDIX B: USEFUL WEB SITES	66

ACKNOWLEDGMENTS

This publication was funded in part from the Renaissance Kentucky Alliance appropriation in 2001. These Design Guidelines were prepared by members of the Renaissance/Main Street Glasgow History and Architecture Committee, the Glasgow Historic Preservation Commission, representatives of the Glasgow City Council, individual property owners, the general public and Donna G. Logsdon, of Logsdon & Logsdon Architects.

INTRODUCTION

The following Design Guidelines were prepared for the City of Glasgow in an effort to provide recommendations for rehabilitation projects within the Glasgow Public Square Historic District. These guidelines were developed in response to the direct appropriation of funds that the City of Glasgow received from the Renaissance Kentucky Alliance after the City was designated a Silver Renaissance Kentucky Community in September 2000. Additional funding will be supplemented by a low interest revolving loan program offered by the City of Glasgow.

These Design Guidelines are a culmination of many years of historic preservation work in Glasgow that began with a county-wide Historic Resources Survey in 1979. As a result of the survey, historic resources were map coded on U.S.G.S. topographic maps with 328 historic resources in the county and 160 historic resources in the City of Glasgow documented on Kentucky Historic Resources Inventory Forms. In 1983, the Southwest Glasgow Residential Historic District Neighborhood and the North Race Street Historic District Neighborhood were listed in the National Register of Historic Places. In 1992, students from Western Kentucky University conducted a survey of the Glasgow Commercial District and listed it in the National Register of Historic Places in 1993.

In 2001, the South Central Kentucky Historical and Genealogical Society received a grant from the State Historic Preservation Office to conduct another county-wide survey to record the status of the previously surveyed buildings and document those historic resources that are over 50 years old.

On January 28, 2002, a Historic Preservation Ordinance was adopted by the City of Glasgow and the Glasgow Historic Preservation Commission, herein after referred to as the "Commission", was established as set forth by Section III.a. In 2002 a county-wide survey of historic resources was conducted and the adoption of these design guidelines for changes to designated properties is being prepared as stated in Section IV.a.

WHY ESTABLISH DESIGN GUIDELINES?

Cultural resource protection on the state and local level is growing across the country. During the 1980s many states passed legislation that mandated that preservation be integrated into local and state planning efforts. An estimated 2,000 communities across the country have chosen to implement historic preservation plans and design guidelines that preserve and protect the historic integrity of their communities. The reasons for establishing design guidelines are both aesthetic and economic. The preservation of historic resources helps to enhance a community's sense of character and identity. An active preservation policy maintains and promotes property values and encourages heritage tourism. Preservation is also increasingly seen as a revitalization tool for communities.

Glasgow has experienced continuous growth since the mid-1800s. The architectural character of this Renaissance Kentucky Area is diverse with a cluster of 20th Century Commercial buildings in the downtown area surrounding the county courthouse core and a wide variety of architectural styles appearing in residential and commercial areas that radiate outward from the central core.

The adoption of these design guidelines fulfills the Historic Preservation Commissions desires to allow the district to visibly grow, change, and improve while preserving Glasgow's quality of life. The intent of this manual is to establish standard objective criteria on which to base design decisions for continued preservation and rehabilitation of their historic resources as well as helping the Historic Preservation Commissioners to determine appropriateness and compatibility. They also offer suggestion for appropriate designs and materials for rehabilitation, restoration and new construction to developers and property owners. Therefore, property owners are encouraged to refer to these design guidelines when planning building rehabilitation, designing new construction projects, and performing regular maintenance work.

The Glasgow Historic Preservation Design Guidelines 2002 are based on *The Secretary of the Interior's Standards for Rehabilitation and Guidelines for Rehabilitating Historic Buildings* that were developed for all national preservation programs and for advising federal agencies on the preservation of properties listed or eligible for listing in the National Register of Historic Places.

THE SECRETARY OF THE INTERIOR'S STANDARDS FOR REHABILITATION

1. A property shall be used for its historic purpose or be placed in a new use that requires minimal change to the defining characteristics of the building and its site and environment.
2. The historic character of a property shall be retained and preserved. The removal of historic materials or alteration of features and spaces that characterize a property shall be avoided.
3. Each property shall be recognized as a physical record of its time, place, and use. Changes that create a false sense of historical development, such as adding conjectural features or architectural elements from other buildings, shall not be undertaken.
4. Most properties change over time; those changes that have acquired historic significance in their own right shall be retained and preserved.
5. Distinctive features, finishes, and construction techniques or examples of craftsmanship that characterize a historic property shall be preserved.
6. Deteriorated historic features shall be repaired rather than replaced. Where the severity of deterioration requires replacement of a distinctive feature, the new feature shall match the old in design, color, texture, and other visual qualities and, where possible, materials. Replacement of missing features shall be substantiated by documentary, physical, or pictorial evidence.
7. Chemical or physical treatments, such as sandblasting, that cause damage to historic materials shall not be used. The surface cleaning of structures, if appropriate, shall be undertaken using the gentlest means possible.
8. Significant archaeological resources affected by a project shall be protected and preserved. If such resources must be disturbed, mitigation measures shall be undertaken.
9. New additions, exterior alterations, or related new construction shall not destroy historic materials that characterize the property. The new work shall be differentiated from the old and shall be compatible with the massing, size, scale, and architectural features to protect the historic integrity of the property and its environment.
10. New additions and adjacent or related new construction shall be undertaken in such a manner that if removed in the future, the essential form and integrity of the historic property and its environment would be unimpaired.

GLASGOW HISTORIC DISTRICTS: NATIONAL REGISTER VS. LOCAL HISTORIC DISTRICTS

On January 28, 2002, the City of Glasgow adopted the Glasgow Historic Preservation Ordinance that established a Historic Preservation Commission and authorized the designation and protection of historic preservation districts and individual landmarks.

National Register District

In 1983, the Southwest Glasgow Residential Historic District Neighborhood and the North Race Street Historic District Neighborhood were listed in the National Register of Historic Places. In 1993, the Glasgow Commercial District was listed in the National Register of Historic Places.

The National Register of Historic Places is a national listing of buildings, sites, districts, structures and objects of local, state and national significance. Listing in the National Register of Historic Places recognizes these historic resources for their importance but offers limited protection. Unless Federally funded or licensed projects are involved, alterations, new construction, demolition or relocation are not prohibited or reviewed. Historic Rehabilitation tax credits are available for qualifying buildings in National Register districts.

Unlike the National Register of Historic Places, Local Historic Districts provide protection for the historic character of the site, building or district. The reason for creating a local historic district is to prevent unregulated and insensitive changes to the building's exterior appearance or the development on a vacant site. Property owners must apply for a Certificate of Appropriateness from the Historic Preservation Commissioners in order to receive approval on exterior alterations, new construction, demolition or relocation.

A Local Historic District is similar to a National Register District in many ways:

The two can be used independently or cooperatively to protect a community's resources. Like the National Register District, the Local Historic District identifies historically and architecturally significant buildings with recognition based on locally developed rather than national, criteria and policies. Local significance, attitudes and contemporary events affect what a community views as important. Because properties less than 50 years old are generally not eligible for National Register listing, the National Register may not serve as a good measure for identifying and evaluating more recent character defining development in a community. It is therefore, possible to include in a Local Historic District, religious institutions, moved buildings, and properties less than 50 years old, which are not ordinarily considered for listing in the National Register of Historic Places.

The primary strength of a local historic district is that it is tailored to the specific community's needs and provides greater protection for local resources. The Historic Preservation Commission members have the means to assure that proposed changes are sympathetic to the character of the district through the design review process.

Local Historic Districts are:

1. Geographically definable areas with a significant concentration of buildings, structures, sites, spaces or objects unified by past events, physical development, design, setting, materials, workmanship, sense of cohesiveness or related historical and aesthetic associations; and
2. Overlay zoning districts designed to protect and preserve areas and structures that possess unique historic and architectural characteristics.

Local Historic Districts accomplish the following:

Protect investments of owners and residents of historic properties by encouraging the purchase and rehabilitation of properties because the investment is better protected over a longer period of time;

Encourage better quality design by using the Design Guidelines that have been specifically tailored to the district;

Help the environment by recycling old buildings;

Provide educational benefits since the existing buildings help explain the historical development of a place, and become a source of inspiration and technological advances;

Serve as a positive economic impact from tourism because a district that is cohesive and well promoted can be a community's most important attraction;

Enhance business recruitment potential since vibrant commercial cores attract new business and quality industry; and

Offer social and psychological benefits because people feel comfortable in human scale environments and desire to live and work in attractive surroundings.

Local historic districts require property owners to receive a Certificate of Appropriateness before undertaking exterior alterations, new construction, relocation or demolition.

Members of the Glasgow Historic Preservation Commission will review the proposed work and upon approval issue a Certificate of Appropriateness. The purpose of the committee's review is to insure that the proposed work will maintain the historic character of the structure within the district and to give property owners assistance and advice on appropriate methods and materials.

LOCAL HISTORIC DISTRICT MAP

The Glasgow Historic Preservation Design Guidelines apply to the designated local historic district and are limited to proposed external changes to existing buildings, structures and sites, and new development. **Any person desiring new construction, alteration, restoration, relocation or demolition of an historic building, structure, site, or object that is visible to the public within this area must submit an application to the Glasgow Historic Preservation Commission for approval.**

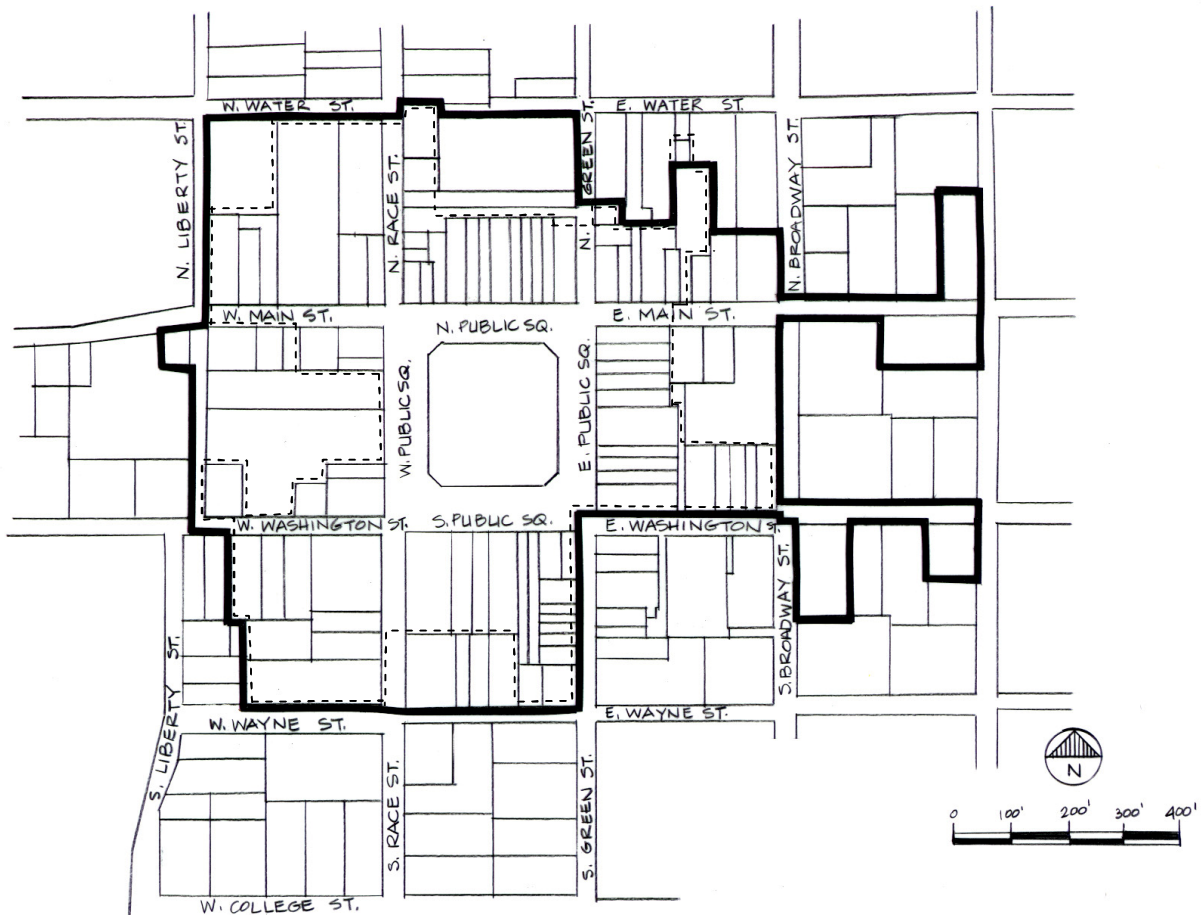

- Existing National Register
Historic District Boundaries - 2004
- Proposed Local Historic
District Boundaries
Approved 11-11-02

GLASGOW PUBLIC SQUARE HISTORIC DISTRICT

GLASGOW PUBLIC SQUARE HISTORIC DISTRICT BOUNDARY DESCRIPTION

Beginning at a point in the northwest corner of the district at the intersection of North Liberty Street and West Water Street, thence continuing eastward along the south side of West Water Street, thence turning northward along the west side of North Race Street, thence turning eastward across North Race Street and continuing eastward along the north side of Block 21, lot 1, thence turning southward along the east side of Block 21, lot 1, thence turning eastward along the north side of Block 21, lot 2, then turning southward along the west side of North Green Street, thence turning eastward across North Green Street and continuing eastward along the north side of Block 29, lot 13, thence turning southward along said lot, thence turning eastward along the southern lot line of lot Block 29, 2A, thence turning northward along the east side of Block 29, lot 8, thence turning eastward along north side of said lot, thence turning southward along the east side of said lot, thence turning eastward across Block 29, lot 4, and continuing eastward along the north side of Block 29, lot 6, thence turning southward along the west side of North Broadway Avenue, thence turning eastward along the north side of East Main Street, thence turning northward along the west side of Block 35, lot 3, thence turning eastward along the north side of said lot, thence turning southward along the east side of said lot, continuing south along the west side of North Broadway Street across East Main Street, thence turning westward along the south side of Block 36, lot 2A, thence turning north along the west side of said lot, thence turning westward along the south side of East Main Street, continuing across North Broadway Street, thence turning southward along the west side of North Broadway Street, then turning east along the north side of East Washington Street to the corner of South Lewis Street, thence turning southward along the east side of Block 37, lot 4, thence turning westward along the south side of said lot, thence turning northward along the west side of said lot, then turning westward along the south side of East Washington street, thence turning southward along the east side of Block 37, lot 1, thence turning westward along the south lot line of said lot, thence turning northward along the west side of said lot, thence turning westward along the north side of East Washington Street, then turning southward along the west side of South Green Street, thence turning westward along the north side of West Wayne Street, continuing across South Race Street, thence turning northward along the west side of Block 15, lot 9, continuing northward along the west side of lot 5, thence turning westward along the south side of lot 3, thence turning northward along the west side of said lot to West Washington Street, thence turning westward along the south side of West Washington Street, thence turning northward along the west side of North Liberty Street, thence turning west along the south side of Block 8, lot 6, thence turning northward along the west side of said lot, thence turning eastward along the south side of West Man Street, thence turning northward along the east side of North Liberty Street to the point of beginning at the intersection of North Water Street.

THE REVIEW PROCESS

Requirement for Certificate of Appropriateness

A Certificate of Appropriateness shall be required before a person may undertake the following actions affecting a landmark or a property in a historic preservation district:

1. Alteration of the exterior of a building or structure that is visible to the public;
2. New construction;
3. Demolition; or
4. Relocation.

Application to the Commission

A Certificate of Appropriateness application form is available at Renaissance/Main Street office. When a person wishes to undertake an exterior alteration visible to the public affecting a landmark, a landmark site, or a property in a historic district that does not require a building permit, that person shall apply directly to the Commission for a Certificate of Appropriateness.

When seeking a building permit from the City government, the City Code Enforcement Officer shall forward to the Commission every application for a permit that would authorize an exterior alteration visible to the public, new construction, demolition or relocation affecting the landmark, landmark site, or a property in a historic district. The Code Enforcement Officer shall give the applicant a form from the Commission requesting additional information from the application.

The applicant shall supply the Commission with the information it requests in order to reach a decision on his application for a Certificate of Appropriateness. The applicant shall provide, where applicable, drawings of the proposed work, photographs of the existing building or structure or site and adjacent properties, and information about the building materials to be used.

Stop Work Order - Injunction

In the event work is being performed without the required Certificate of Appropriateness, the City Code Enforcement Officer shall issue a Stop Work Order. In the event that work is being performed which is not in accordance with such certificate, the City Code Enforcement Officer shall issue a Stop Work Order and any law enforcement officer may cite violators in District Court. All work shall cease on the designated property. No additional work shall be undertaken as long as such Stop Work Order shall continue in effect. The Historic Preservation Commissioners shall meet with the owner or tenant to resolve the problem. The City may apply in Circuit Court for an injunction to enforce its Stop Work Order.

In the event work requiring a Certificate of Appropriateness but not a Building Permit is being performed without the required Certificate of Appropriateness, the Code Enforcement Officer shall issue a Stop Work Order and any law enforcement officer may site violators to District Court. All work shall cease on the designated property. No additional work shall be undertaken as long as such Stop Work Order shall continue in effect. The City may apply in Circuit Court for an injunction to enforce its Stop Work Order.

Action by the Glasgow Historic Preservation Commission

The Commission shall hold a public hearing on each Certificate of Appropriateness within thirty (30) days after a completed application is received by the Commission. The Commission shall make a decision on the application within forty-five (45) days after the receipt of a completed application provided that the Commission may extend the time for decision an additional sixty (60) days when the application is for demolition or new construction. The Commission shall approve or disapprove each application, and it shall give its reasons for its decision using the criteria contained in these guidelines. The Commission may suggest modifications to an application and may then approve a Certificate of Appropriateness providing for revisions in the plans submitted. If the Commission fails to decide on an application within the specified time period, the application shall be deemed approved.

Notice of the public hearing shall be given at least fourteen (14) days in advance of the hearing by first-class mail, with certification by the Commission secretary or other appointed officer that the notice was mailed to the Applicant and to an owner of every parcel of property adjoining the subject property. It shall be the duty of the Applicant to furnish the Commission the names and addresses of the owners of all adjoining property. Records maintained by the property valuation administrator may be relied upon conclusively to determine the identity and address of the owner. If the property is in condominium or cooperative forms of ownership, the person notified by mail shall be the president or chairman of the owner group which administers property commonly owned by the condominium or cooperative owners. A joint notice may be mailed to two (2) or more co-owners of an adjoining property who are listed in the property valuation administrator's records as having the same address.

Notice shall be published in a newspaper of general circulation in Glasgow at least seven (7) and no more than twenty-one (21) days before the public hearing in accordance with KRS Chapter 424. In addition, notice shall be posted conspicuously on the subject property for fourteen (14) consecutive days immediately prior to the public hearing. The Commission may include in its application fee a charge for the cost of giving notice of the public hearing. When an application has been approved, the Applicant shall be given a Certificate of Appropriateness.

Criteria in Deciding on Applications

In making a decision on an application, the Commission shall use these Design Guidelines and the guidelines it has adopted for that landmark or historic district. The Commission shall consider: (1) the effect of the proposed work on the landmark or the property in the historic district upon which work is to be done; and (2) the relationship between such work and other structures on the landmark site or other property in the historic district. In evaluating the effect and the relationship,

the Commission shall consider historical and architectural significance, architectural style, design, arrangement, texture, materials and color. The Certificate of Appropriateness from the Commission shall not relieve the applicant from complying with the requirements of other State and local laws and regulations.

Consultation with Applicants

In making a decision on an application, the Commission shall be aware of the importance of finding a way to meet the current needs of the applicant. The Commission shall also recognize the importance of approving plans that will be reasonable for the applicant to carry out. Before an applicant prepares his/her plans, he/she may bring a tentative proposal to the Commission for its comments.

Routine Alterations - Ordinary Maintenance

The Commission shall prepare a list of routine alterations that shall receive immediate approval from the Chairman or Vice-chairman of the Commission without a public hearing when an applicant complies with the specifications of the Design Guidelines. The list shall include suggested paint colors appropriate for different types of building such as repairs to doors, windows, awnings, roofs, etc. At each meeting the Commission shall be informed of the Certificates of Appropriateness that have been issued under this provision.

Ordinary repairs and maintenance may be undertaken without a Certificate of Appropriateness provided this work on a landmark, a landmark site or a property in a local historic district does not change its exterior appearance that is visible to the public. Every person in charge of a landmark or a property in a historic district shall keep in good repair: (1) all of the exterior portions of such buildings or structures; and (2) all interior portions thereof which, if not so maintained, may cause such buildings or structures to deteriorate or become damaged or otherwise to fall into a state of disrepair. The purpose of this provision is to prevent a person from forcing the demolition of his building by neglecting it and by permitting damage to the building because of weather or vandalism. No provision in these Design Guidelines shall be interpreted to require an owner or tenant to undertake an alteration or to restore his building to its original appearance. The provisions of these Design Guidelines shall be in addition to the provisions of the Kentucky Building Code requiring buildings and structure to be kept in good repair.

Emergency situation

An owner shall immediately notify the City Code Enforcement Officer of emergency conditions dangerous to life, health, or property affecting a landmark, a landmark site, or a property in a local historic district and the owner shall promptly provide evidence of the dangerous conditions that has been prepared by a person with professional qualifications in evaluating buildings and structures.

At its next meeting the Commission shall be informed of the Certificates of Appropriateness that were issued. In situations requiring temporary action, an owner may do work in order to

temporarily protect his property from further damage provided he reports this work to the Commission within two (2) business days.

In any case where the City Code Enforcement Officer determines that there are emergency conditions dangerous to life, health or property affecting a landmark, a landmark site, or a property in a historic district, he/she may order the remedying of these conditions without the approval of the Commission. The City Code Enforcement Officer shall promptly notify the Chairperson of the Commission of the action being taken. If consultation is not possible, the City shall notify the Commission of the action taken after the completion of the work.

In the case of unusual circumstances whereby the normal process for obtaining a Certificate of Appropriateness creates undue hardship for the health, safety and welfare of the applicant, the Commission may at its discretion waive the normal process and give immediate approval for a Certificate of appropriateness. The Commission shall site its reasons for such immediate approval.

Conformity with the Certificate of Appropriateness

All work performed pursuant to a Certificate of Appropriateness shall conform to the provisions of such Certificate. It shall be the responsibility of the Commissioners or its designee to inspect from time to time any work being performed to assure such compliance. In the event work is being performed which is not in accordance with such Certificate, the City shall issue a Stop Work Order. All work shall cease in the designated property. No additional work shall be undertaken as long as such Stop Work Order shall continue in effect. The Commission shall meet with the owner or tenant to resolve the problem. The City Attorney may seek in Circuit Court an injunction and any other appropriate relief in order that the intent of these Design Guidelines shall be carried out.

Length of Validity of a Certificate of Appropriateness

A Certificate of Appropriateness shall remain valid for one (1) year after it is issued. Work is required to start before the end of the one year period. If the approved work has not been completed within two (2) years after the Certificate of Appropriateness was issued, the Commission shall review the situation and may require an application for a Certificate of Appropriateness for the work that remains to be done.

Appeal of Commission's Decision

Any party in interest shall have a right to appeal to the City Council any decision of the Commission regarding an application for a Certificate of Appropriateness. Such appeal must be filed in writing with the Glasgow City Clerk within fourteen (14) days after the final decision of the Commission. The City Council shall hold a public hearing and shall vote on said appeal within sixty (60) days of its receipt. The City Council shall transmit its decision in writing to the applicant, the Commission, and the City Code Enforcement Officer.

Demolition

When an applicant wishes to demolish a landmark, a building or structure on a landmark site or a building or structure in the local historic district, the Commission shall negotiate with the applicant to see if an alternative to demolition can be found. The Commission may ask interested individuals and organizations for assistance in seeking an alternative to demolition and in obtaining estimates on rehabilitation costs for the threatened building. After its public hearing, the Commission may decide that a building or structure in the historic district or on a landmark site in the local historic district may be demolished because it does not contribute to the historic district or to a landmark. On all other demolition applications, the Commission shall study the question of economic hardship for the applicant and shall determine whether the landmark or property in the local historic district can be put to reasonable beneficial use without the approval of the demolition application. In the case of an income-producing building, the Commission shall also determine whether the applicant can obtain a reasonable return from his/her building. The Commission may ask applicants for additional information to be used in making these determinations. If economic hardship or the lack of a reasonable return is not proved, the Commission shall deny the demolition application unless the Commission finds grounds to grant the demolition application as outlined in under "Criteria in Deciding on Applications".

Moving a landmark or a building or structure in a Historic Preservation District

When an applicant wishes to move a landmark, a building or structure on a landmark site, or a building or structure in a local historic district or when an applicant wishes to move a building or structure to a landmark site or a lot containing a landmark or to a property in a local historic district, the Commission shall consider:

- (1) the contribution the building or structure makes to its present setting;
- (2) whether there are definite plans for the site to be vacated;
- (3) whether the building or structure can be moved without significant damage to its physical integrity; and
- (4) the compatibility of the building or structure to its proposed site and adjacent properties.

These considerations shall be in addition to the points contained under "Criteria in Deciding on Applications".

DESIGN GUIDELINES

Overall Approach and Policy

The Design Guidelines serve two important purposes within the context of an overall preservation plan. First, they provide the Historic Preservation Commission with uniform standards on which to base design review decisions. Secondly, they provide to property owners the necessary information about respectful rehabilitation and construction within an historic district. This information is helpful when property owners are designing alterations or planning for new construction in an established historic district.

The principal philosophy behind these Design Guidelines is the emphasis on preservation over complete restoration. This outlook is demonstrated through the use of such words as *repair*, *retain*, *maintain*, and *protect*. It is important to *repair* historic elements rather than replace them; *retain* original landscaping features like cast iron fences and stone retaining walls; *maintain* the original fabric because it is integral in displaying historic character; and *protect* the original setting of the house to protect its integrity.

Design Guidelines take into account all the aspects that define the historical character of a building and its surroundings. The Guidelines apply to all facade of a building but may be interpreted differently between rear facades and primary and secondary facades that are readily visible from the street. **Guidelines apply only to the exterior of the buildings, streetscapes, landscaping, and parking. Interior appearance is not regulated.** Preservation of the original streetscape is also important in maintaining the original character of the neighborhood.

This manual includes a map of Glasgow's Local Historic District that shows the boundaries that these Design Guidelines govern. Chapters covering Site and Setting, Rehabilitation, New Construction; Demolition and Relocation offer recommendations for alterations following *The Secretary of the Interior's Standards for Rehabilitation*. Procedural, technical and architectural terms are clearly defined under Definitions and the Appendices include a Suggested Bibliography for further research on architectural history, historic restoration and rehabilitation, and materials conservation.

For the purpose of these guidelines, certain words shall be interpreted as follows:

"shall"	a mandatory action
"should"	a preferred action
"may"	a preferable action

SITE AND SETTING

Parking Facilities:

Parking to the sides and rear of buildings is encouraged.

Lighting:

Exterior lighting should be designed to enhance the building.

Light sources should be shielded where possible to avoid direct glare.

If historic light fixtures can be accurately documented and duplicated, the historic fixture should be used in a manner similar to its original purpose and locations.

If no documentation is available, or a historic fixture cannot be duplicated, then a contemporary lighting fixture should be used.

Contemporary light fixtures should be compatible in scale with existing architectural features, but should not imitate a period.

Fixtures should be brass, copper or painted metal on posts of wood, cast iron or painted metal.

Small footlights, simple and unobtrusive in design, are preferable to freestanding post-mounted lights for walks and driveways.

Preserve and maintain existing original light fixtures when possible.



Historic light fixture

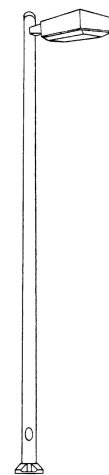

Contemporary light fixture

Landscaping:

Retention and protection of mature shade trees is encouraged.

Native plants, trees, and shrubs should be planted and local historic landscape patterns should be preserved.

All undeveloped or under utilized areas shall be maintained in a landscaped condition. Landscape elements considered include all forms of planting and vegetation, ground forms, rock groupings, water patterns and other visible elements except principle buildings and accessory buildings.

Plant materials should be selected for interest in its structure, texture, color and mature size. Provision of shade in paved areas is encouraged. Landscape treatment should enhance architectural features, strengthen views and provide shape or form to outdoor spaces.

Accessory Buildings:

Original outbuildings such as sheds and garages should be maintained and preserved. Repair and replacement of original elements is recommended. New outbuildings should be constructed of wood-frame, with clapboard siding, gabled roofs and single or multi-light sash windows. New brick or stone outbuildings are also acceptable.

Mechanical and electrical systems should not be visible from the public right-of-way, and should be screened from the right-of-way and adjoining properties with either a fence, wall or vegetation.

Satellite dishes, radio antennae, and other signal receiving devices should not be constructed to be visible from the public right-of-way. Rear area is the only appropriate location for satellite dishes and similar devices. Satellite dishes should be screened from public view with landscaping or a fence.

Recreational Structures:

It is desirable to have swimming pools, tennis courts and other recreational structures and facilities located in the rear area. Screen the yard with fencing or landscaping to mask recreational structures from public view.

Outbuildings:

Original outbuildings such as sheds and garages should be maintained and preserved.

Documenting an outbuilding through photography and/or drawings should take place prior to demolition.

Outbuildings: continued

Replacement of outbuildings should be of frame construction-simple clapboard siding, gable roofs, and multi-light sash windows. New brick or stone outbuildings are also acceptable as long as they are located in the rear yard or along an alley.

Demolition of wood outbuildings which require extensive repair or replacement of at least half of the exterior siding and have badly deteriorated roof structures is permitted.

Fences:

Preserve and maintain historic fence materials and design.

New fences in historic materials and designs are appropriate.

Only fences that are compatible with historic designs and materials should be constructed on front and exterior side lot lines.

Wood privacy fences and solid wall fences of wood, brick or concrete may be built to a height of 7'-0" maximum along the interior side and rear property lines. Solid wooden board fences, solid wall fences and chain link fences are not appropriate **unless** screened by trees, shrubs or foliage or are not visible from the public right-of-way. Shrubs, trees or low foliage is recommended.

The use of ivy or other creeping cover is recommended to screen and soften the look of existing chain link or wire fences.

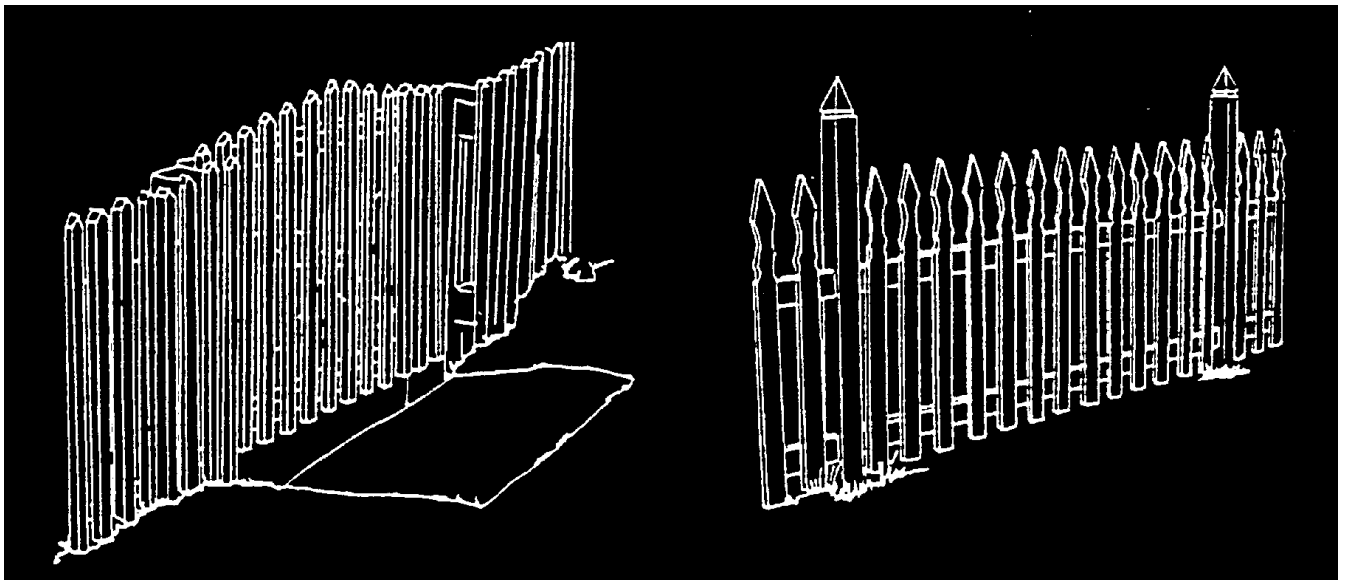

Traditional picket fences

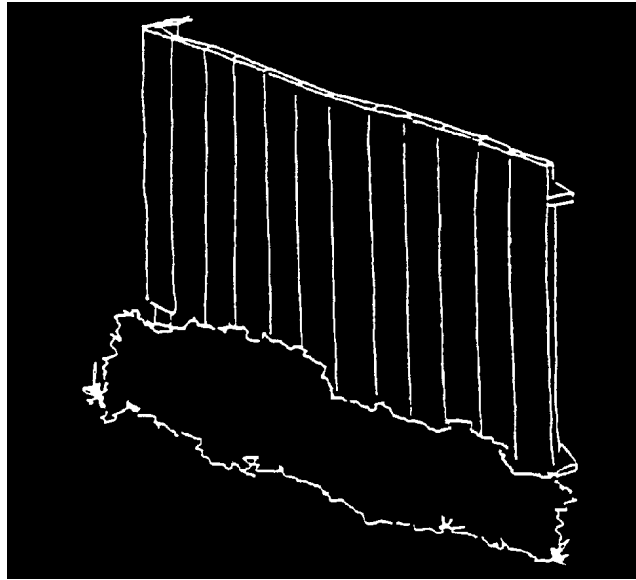

Appropriate plank fence

Driveways:

Parking area in residential areas should not be constructed so that the main facade of the house is obscured.

REHABILITATION

Building Use:

Historic structures within the district should be used for their originally intended purpose or for an alternate commercial purpose that requires minimal alteration to the building and site.

Maintenance:

Ordinary maintenance or repair of an exterior feature which does not involve a change in the design, material or outer appearance is encouraged. The owner of, or person in charge of a structure within the district, shall not let the structure fall into a state of disrepair which may result in the deterioration of any exterior appurtenance or architectural feature which contributes to the structural integrity so as to produce or intend to produce, a detrimental effect upon the character of the district or the structural viability of the structure. The items shall include the deterioration of: exterior walls or other vertical supports, roofs or other horizontal members; exterior chimneys; fences; exterior finishes such as shingles, stucco, paint and mortar; the ineffective water-proofing of the property including broken windows or doors; any architectural feature so as to create or permit a hazardous or unsafe condition; any architectural feature which contributes to the architectural and historic significance and/or integrity of the structure.

Facade Materials:

The restoration of the original facade building material will be reviewed by the Commission to determine the nature of the facade restoration requirements.

The building materials selected should reflect typical materials used in the area. Facade veneer materials, especially if not utilized as a continuous facade material, are discouraged if not original. Use of veneer materials may be allowed depending upon the validity of the design in relationship to the building in question, as well as to the community as a whole.

It is especially important to restore or recreate building details where records can indicate their original design and role in the architectural composition. Raised details and projections may be enhanced by color to highlight this feature as an integral element of the facade.

Details that are seen as contributing to the overall district character should be retained, repaired, replaced or duplicated if necessary. The removal or alteration of any building material or distinctive architectural feature is not recommended unless approved by the Commission.

Existing alterations that are seen as contributing to the character of the district should also be retained. The removal of alterations that are not contributing is recommended.

Paint and Color:

Painting masonry or stucco that has never been painted is not recommended. The presence of a lead oxide wash does not constitute a precedent for painting a building.

Paint is difficult to remove, accumulated layers will obscure decorative detail, and paint coating will affect the wall's vapor transmission performance. When removing paint from previously painted masonry, use gentle treatments that have been previously tested in an inconspicuous location. Do not sandblast or use acid-based cleaners.

If painting previously painted masonry, select a color that matches the existing color, approximates a natural masonry color, or colors recommended by the committee.

Use breathable masonry paint that is compatible with and can create a strong bond with the existing paint on previously painted masonry only.

Paint replacement gutters, downspouts, metal frame screen, storm doors and windows, roof-vent assemblies, and fire escapes to match wall, trim, cornice, or roof color of the building whichever is most effective in reducing the visibility of these elements.

Exterior paint colors should be in keeping with a building's style and time period.

Have paint samples analyzed when possible. Paint studies can determine historic pigments and appropriate colors for repainting by analyzing a paint sample under special lighting conditions to ascertain specific color, hue, and value of paint layers.

Intense or dark colors are discouraged on non-masonry primary building facades. Light, subdued, or neutral colors are recommended. Accent colors are encouraged to emphasize architectural detailing, such as awnings, detailed parapet walls, bulkheads, cornice work and overhanging projections. Window frames and sashes should compliment the main building color. Light to medium colors in wood stains are encouraged.

Storefronts:

Maintain the commercial character of the storefronts, even if they have changed use.

Retain the original scale, proportion, materials and organization of architectural elements, bulkheads, display windows, transoms, doors, pilasters, and cornices when renovating historic storefronts.

Retain original storefront features such as display windows, signs, doors, transoms, kick plates, corner posts and entablatures including later alterations that are historic in their own right. Respect facade alterations that have attained historic or architectural significance.

Storefronts: continued

When designing and constructing a new storefront that is completely missing, historical, pictorial or physical documentation should be used. The design may be an accurate restoration, if sufficient evidence exists, or a new design may be allowed that is compatible with the size, scale, material and color of the historic building.

Work to incorporate existing elements into the new storefront design or renovation. Recreating a conjectural historic design if there is insufficient physical or documentary evidence, is not recommended.

Use the original form and detailing of a storefront as a model if extensive deterioration requires complete reconstruction. The reconstruction should convey the same visual appearance and use the same materials as the original to the extent possible. Historic storefronts that are removed should be replaced.

Retain the location of the main entrance of a storefront.

Using materials that were not available at the time of original construction in storefront renovations, such as vinyl or aluminum siding, tinted glass, or artificial stone is not recommended. Retain historic storefront materials such as wood, cast iron, terra cotta, Carrara glass, ceramic tile, and brick that contribute significantly to a storefront's architectural character.

Removal of later historically significant material to restore a building to an earlier period is not recommended.

Adding elements to storefronts that have no historic precedence is not recommended. Common examples of inappropriate alterations include the installation of coach lanterns, false mansard roofs, small-paned windows and inoperable shutters.

Adding false fronts, false stories or pent eaves to the roofs of commercial buildings is not recommended.

Design replacement storefronts that are compatible with and complimentary to the character of the historic district and are recognizable as being of their own era. Where feasible, include the following storefront elements when redesigning or renovating a historic storefront: large display windows and doors, transoms, relatively thin framing elements, and low bulkheads.

Keep storefront designs within their original openings. Transitions from one facade to another should be clean and clearly defined.

Select replacement doors that reflect the storefront's original character. Doors should have large glass panels and be made of wood or painted steel or aluminum. They should not be overly decorated or possess inappropriate historic features.

Storefronts: continued

Protect and maintain masonry, wood and architectural metals through cleaning, rust removal, limited paint removal and reapply protective coatings systems as necessary. Replace missing features or those features that have deteriorated with similar materials and design. If the same material is not technically or economically feasible, then compatible substitute materials may be considered.

Conjectural or falsely-historical designs are not appropriate.

Use historical, pictorial and physical documentation when undertaking the reconstruction of missing elements. If there is not sufficient information to determine the original design, a new design should be prepared that is compatible with the architectural character of the building.

Doors:

Replacement of original doors, as well as decorative features, should be done only in cases of significant deterioration. Replacement materials should match original doors and decorative features materials where possible.

New or replacement doors on primary or visible secondary facades should be of appropriate design for pre-1950 residences. For residences built between 1880 and 1915 this may include single light glass and wood doors with four or five recessed panels. Doors with multiple glass light designs or single light designs are appropriate for residences built between 1915 and 1940.

Original doors should not be replaced with modern solid core wood doors or other similar variations.

The original appearance of entrance doors should be preserved. Doors that have not been previously painted should be left in their natural condition. The painting of doors that have a grained or stained finish should only take place if the finish is severely weathered.

Screen doors with wood framing members and large screened area are appropriate. Framing should be minimal. Screen doors that match the framing arrangement on doors are appropriate.

Replacing historic double-leaf doors with a single door is not recommended. Do not alter original openings to accommodate stock doors. Replacement of non-original, non-historic doors with new doors that are appropriate to the period and style of building and are the size of the original opening is recommended.

Screen and storm doors shall match the proportions and design of the entrance.

Original wood screen doors should be preserved and maintained.

Doors: continued

New screen doors should be constructed of wood in simple designed, which match the framing design on the original door. Doors with ornate designs of wrought iron or similar metals should not be installed.

Screen doors should be painted with colors to match the entrance.

New storm doors added to entrances on primary facades or visible secondary facades should provide a full view of the original entrance.

Storm doors should be of wood or anodized aluminum in dark colors. Aluminum storm doors may also be installed as long as the door is primed and painted and the raw aluminum surface is concealed.

Storm doors added to rear entrances or entrances on facades not readily visible from the street should be of plain, full view design. Doors of varying types of metal and glass panels are also acceptable.

Security doors should have minimal metal framing and be as full view as possible. Security doors with extensive metal grillwork should not be installed on primary facade but may be installed on rear entrances or entrances not readily visible from the street.

Windows:

Maintain and preserve the original window pattern and details.

Original windows should be maintained and repaired with matching materials. Original windows should be replaced only if the window has deteriorated to the extent that it cannot be repaired. Replacement windows should match the original in dimension and design.

The original window sash configuration should not be altered.

Fixed single light windows, picture windows, and modern metal windows should not be added on primary or readily visible secondary facades on residences.

Original window openings should not be enclosed, reduced, expanded or concealed. New window openings should not be added to the primary facade or readily visible secondary facades.

Original stained glass, leaded glass, and other decorative glass details should not be removed from window openings. Conversely, elaborate stained glass or other decorative glass lights shall not be added to a residence's primary or readily visible secondary facades if there is no evidence that such window features were ever present.

Windows: continued

Original decorative surrounds, sill, lintels and moldings should be preserved when original sashes are in place.

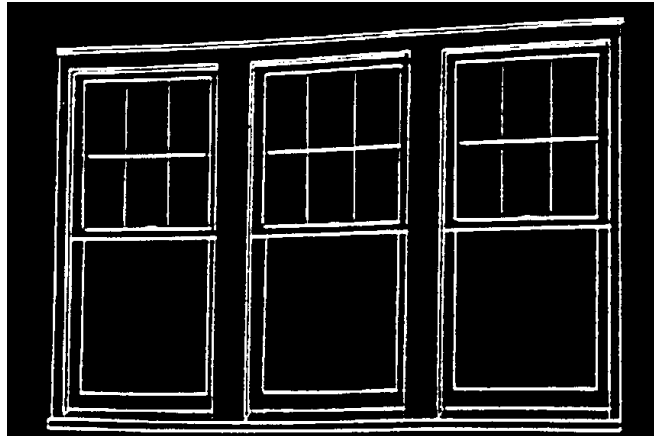

Original window sash and surrounds should be preserved and maintained.

Snap in muntins should not be added to an original window sash.

Broken glass lights should be replaced with glass lights identical to the original. Replacement glass lights should be of clear glass on primary and readily visible secondary facades. Tinted glass may only be installed on rear or secondary facades not visible from the street.

Smoked, tinted, reflective glass, or insulating film applied to window glass on building facades that can be seen from the public right-of-way is not recommended.

Window sash and frames may be painted to contrast the color of the house to provide depth to the window openings.

The original windows that have been covered or removed are recommended to be restored to reflect the original facade design. Window and door sizes and treatments should be the same as the existing except for materials that may be metal or new materials, but should be of similar design.

Blocking in or back painting transoms and sidelights is not recommended.

Windows: continued

Altering the number, size, location, shape or original windows seen from the public right-of-way by making new window openings or permanently filling in existing openings is not recommended.

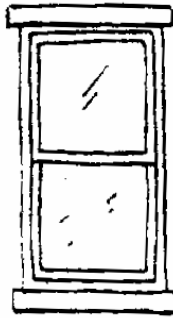

Original window



Inappropriate alterations

Installing new floors or dropped ceilings that block the glazed area of the historic windows is not recommended. If such an approach is required, the design should incorporate setbacks that allow the full height of the window to be seen unobstructed.

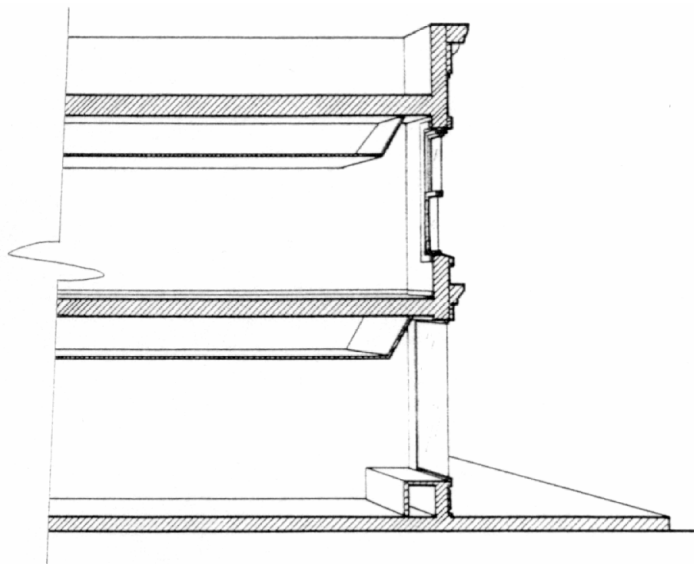

Slope interior ceilings to allow full window height to be unobstructed.

Windows: continued

If windows are no longer needed, operable shutters that fit the window openings are suggested if shutters originally existed. If shutters did not exist, a temporary closure should be prepared, of similar facade materials slightly recessed in the opening leaving the frame intact.

New window openings for a new use may be located on a facade that cannot be seen from the public right-of-way. Newly installed windows should be compatible with the overall design of the building.

Storm windows:

Interior storm windows may be installed if they match the original window opening.

Do not install window air-conditioning units on a primary facade if installation on a secondary facade can address the same need. If this is not an option, the air conditioning unit should fit within the window opening without altering the framework or window sash.

Install exterior storm windows that duplicate the shape of the original window. Storm window frames should be painted to match the color of the window frame. Do not install exterior storm windows or screens that damage or obscure historic windows or frame.

Storm windows or screen rails should always match the rails of the windows behind. They should have either wood or narrow metal frames that are painted to match the color of the building trim.

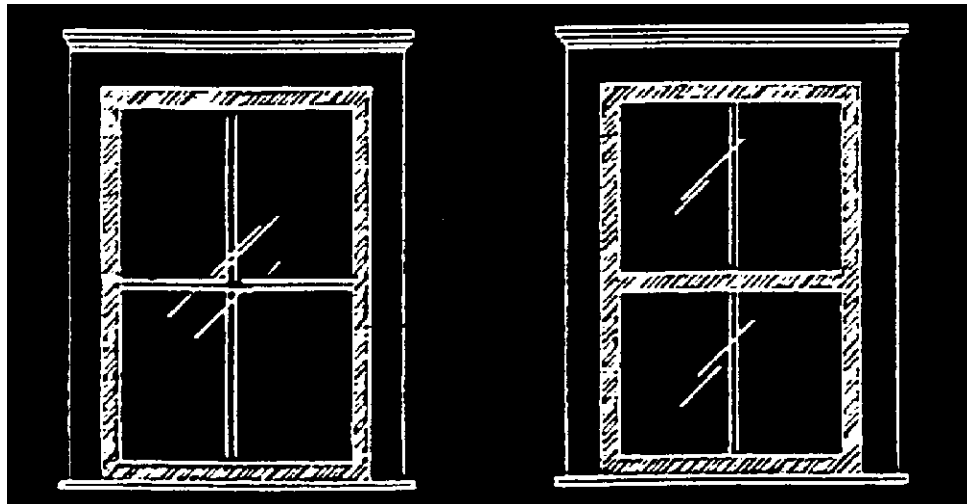

Storm windows should be full view design or match the window's meeting rail.

Shutters:

Original wood shutters should be preserved and maintained.

Window openings that never had shutters should be left in this condition.

Mount replacement shutters so that they partially cover the vertical trim of the window frame to give the appearance that they are operable. Shutters should not be applied to the masonry or cladding on either side of the window.

Install shutters only where there is historic evidence for them. Replacement shutters should be or appear to be operable, be equal to the full height of the windows and be constructed of a historically appropriate materials.

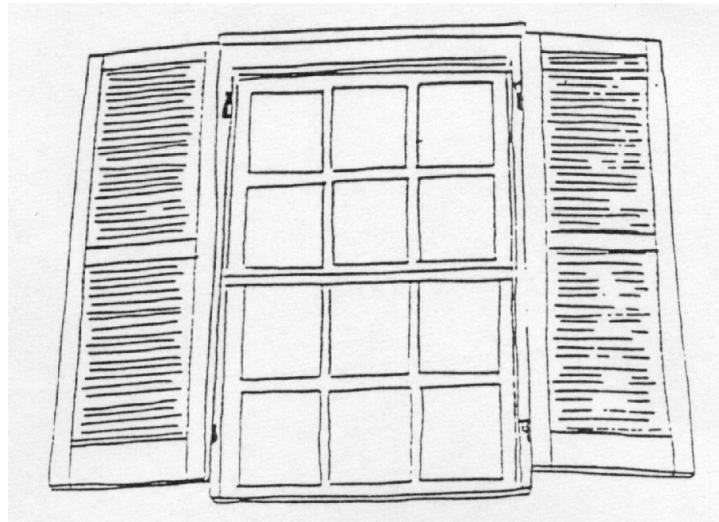

Window shutters should be proportional to their opening.

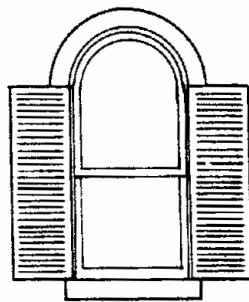

No.

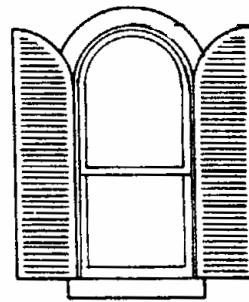

Yes.

Shutters: continued

Shutters should be painted to contrast the color of the house and should match the color of the window trim.

Installation of aluminum or vinyl shutters is not recommended.

Awnings:

Design awnings to complement existing architectural features. Awnings should fully cover window, door or porch openings. Awnings should not be oversized and should not obscure decorative details.

Install awnings so that the valance is no lower than 8'-0" above the sidewalk or grade at any point. Valances should be in keeping with traditional patterns such as straight, scalloped, wave or saw-tooth designs.

Awnings made from matte-finish weather-proofed canvas, vinyl-coated canvas, and acrylic of traditional forms are appropriate and may be used on primary and visible secondary facades. The installation of fixed metal, wood, fiberglass, plastic, vinyl or back-lit awnings is discouraged with the exception of metal or vinyl awnings with a canvas overlay. Shed awnings are appropriate. Bubble, concave, and convex forms are discouraged.

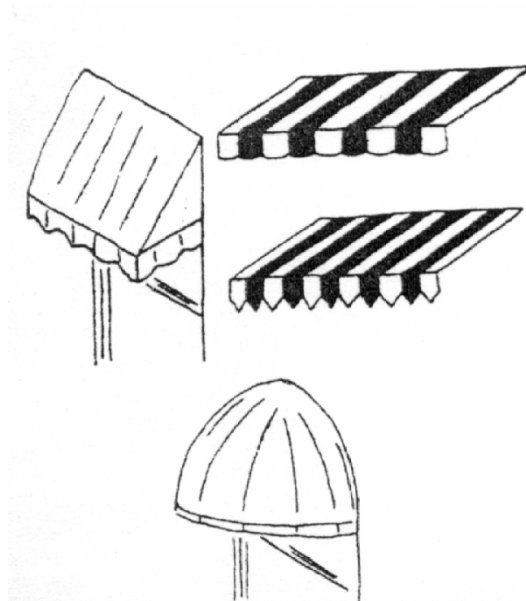

Awning designs

Awnings: continued

Attach awnings between the window display area and the signboard or second-floor window sills. Awnings should be attached below the transom line where historic glass is present.

Awning colors should complement the building's facade colors. The shape and proportion of the awning must be compatible with the character of the building and appropriate for the building's design. The awning shall express the architectural framework, i.e., shape and proportion of the buildings to which they are attached.

The size of the awning should fit the window and the highest point of a first-floor awning shall not be higher than the mid-point of the space between the second story window sills and the top of the first floor window, or transom.

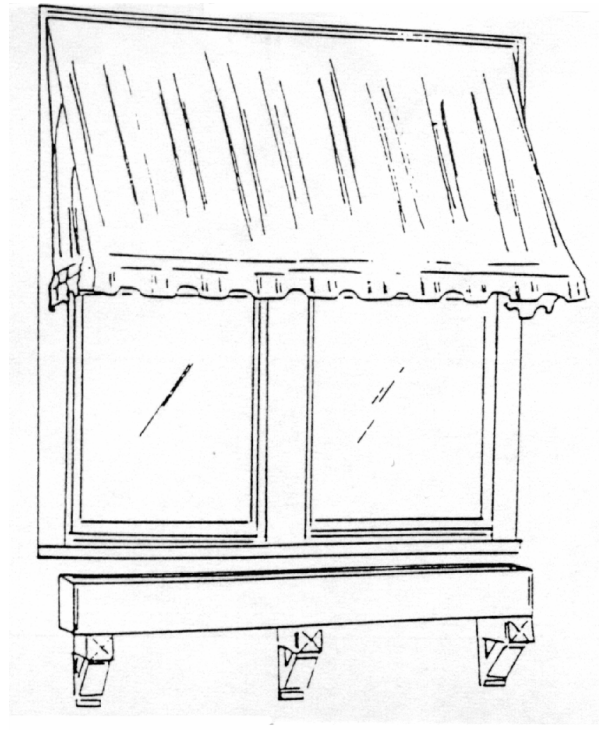

Awning design

Staircases:

Staircases that lead to upper floor entrances should be constructed on rear or secondary facades, not on primary facades or secondary facades readily visible from the street.

Exterior staircases constructed of wood are more appropriate than those of wrought iron or other metal.

Siding and Trim:

Retain the historic fabric to the greatest degree possible. Preserve and retain wood features such as exposed original wood siding and decorative trim. Replace only those portions that are deteriorated with in-kind materials wherever possible. Substitute materials should convey the visual appearance of the original feature, duplicating size, shape, and texture.

Original wood siding should not be covered or replaced.

Original wood siding should be preserved and maintained and not be concealed with synthetic siding materials like aluminum, vinyl, rolled asphalt, composition shingles, or any type of brick or stone veneer.

Original details, soffits, eaves, and porch ceilings should not be concealed with artificial or synthetic materials.

Complete removal of wood siding should not be done unless the original siding has deteriorated beyond repair. Removal should be kept to a minimum.

New wood siding that is used to repair or replace original siding should be of the same material, profile and design as the original.

Orient all siding horizontally unless there is sound historic documentation for a different orientation.

T-111, fiberglass, vinyl, asphalt shingle or aluminum siding are not recommended.

Porches/Balconies:

An original porch should not be removed from its original location because it is inappropriate and results in the loss of the building's integrity.

Removing a porch or balcony that is unrepairable and replacing it with a new porch or balcony that does not convey the same visual appearance is not recommended.

Adding porches to primary facades of buildings that never had porches is not recommended. Covering porch or cornice elements is not recommended. Porches located on primary facades should not be enclosed to create interior living space.

Porch reconstruction may be allowed if there is architectural or documented historical evidence that supports the previous existence of a porch.

Porches and decks may be added to the rear facades as long as they are not easily visible from the street.

Porches/Balconies: continued

Enclosing front porches is not recommended. Screen panels that can be removed seasonally, are set behind porch elements, and do not damage historic fabric may be permitted.



Not recommended.



Recommended.

Porches/Balconies: continued

Replace in-kind an entire porch or balcony that is too deteriorated to repair if the form and detailing are still evident. If using the same kind of material is not technically or economically feasible, then a compatible substitute material may be considered.



Porch and balcony designs

Porch elements that have become deteriorated should be repaired rather than replaced. When the severity of deterioration requires replacement, the new feature should match the original in design, color, texture, and where possible, materials.

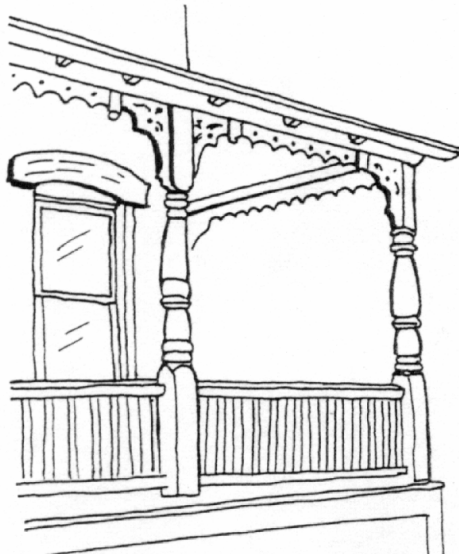

Original columns and railing

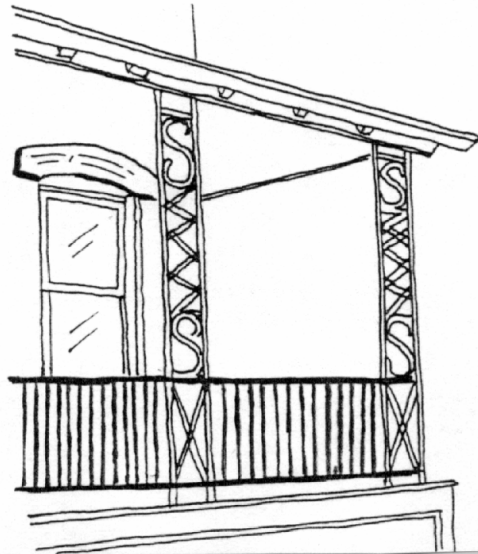

Inappropriate replacement

Porches/Balconies: continued

Design replacement porch railings, balusters, and flooring to match the original as closely as possible.

Repair porches and balconies by reinforcing the historic materials. Replace those elements that have deteriorated or are missing.

Porches on secondary facades may be enclosed with glass or screens set behind the original columns.

Installing porch ceilings or closing in exposed eaves where none existed previously is not recommended. Exposed rafter ends and roof decks are character-defining features.

When installing a new-code required handrails or railings, select a design that is simple and stylistically appropriate. In general, metal is appropriate for masonry buildings and wood for frame buildings.

Replace deteriorated porch steps in the same scale, dimensions, and similar materials as the original.

Floors:

Original porch floors of wood or concrete should be preserved.

Original wood floors should not be replaced with concrete or brick.

Repair deteriorated floors with matching materials.

Columns:

Deteriorated columns should be repaired rather than replaced. Preserve as much of the original column as possible when doing repair work.

Substitute materials should not be used when repairing deteriorated columns. Original porch columns are usually wood and should not be repaired with metal or synthetic materials.

If column replacement is necessary, use wood columns that match the original wood columns on primary facades.

Aluminum or metal columns may be used to repair porches on secondary and rear facades but are discouraged on primary facades.

Original wood or brick columns should not be replaced with decorative wrought iron supports.

Railings:

Original porch rails and balusters should be maintained and preserved.

Repair of original porch rails and balusters is preferred to replacement.

Replacement materials should match the original materials.

Porch railings should not be added where one had not previously existed. If safety considerations require the addition of a porch rail, the design should be simple with square balusters.

Stairs:

Original concrete, brick or wood stairs that lead to an exterior entrance should be preserved and maintained whenever possible. Replacement stairs should be similar in design and materials to the original stair.

Pre-cast concrete stairs should not be placed on the primary facade.

Metal or wrought iron railings or handrails, if required for safety, should be simple in design with square balusters, the use of scroll or corkscrew decorative railings or balusters should be avoided.

Handicap ramps should be located at a secondary or rear entrance where they do not detract from the visual impact of the primary facade.

Entrances:

Original doors that have been removed should be saved.

Maintain and preserve all original entrance features.

Original entrances on primary or readily visible secondary facades should not be altered, enlarged, downsized, or enclosed.

Creating new entrances on facades that can be seen from the public right-of-way is not recommended.

New entrance openings should not be added on primary facades or readily visible secondary facades.

The alteration or removal of original entrances on rear or secondary facades is discouraged but may be allowed.

Entrances: continued

New entrances to multi-family dwellings should be added only to the rear facades or to facades not readily visible from the street. If new entrances are added to these facades, it is recommended that window openings be enlarged to accommodate the new entrance rather than have extensive removal of original materials.

Stylistic components of the entrance should be preserved. This includes original doors, transoms, sidelights and surrounds. Original hardware, locks, and doorknobs should also be retained.

Vestibules added to primary facades are not recommended unless there is a historic precedent. Such additions alter the character, proportion and massing of the facade. New buildings on corner lots may have entrances on both street facades. However, the main entrance should be placed on the façade that is considered to be the primary or dominant façade.

Masonry:

Original masonry should be preserved and maintained.

Exterior masonry elements should not be removed or concealed.

Do not sandblast or use any abrasive method to clean masonry. Sandblasting or high pressure cleaning methods are not acceptable for brick. These methods remove the outer patina or "crust" of the brick and expose the soft inner core that can lead to deterioration.

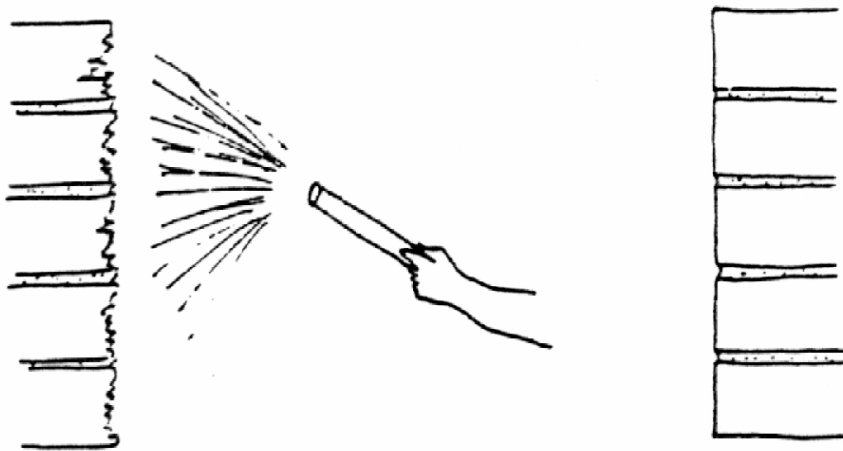

Sandblasting damages masonry and is not recommended

Masonry: continued

Low-pressure water or steam cleaning with a mild detergent and a natural (never metal) bristle brush should be used. Commercially available chemical cleaners or paint removers may be used in combination with water or steam. A test patch of the intended cleaning agent should be conducted and allowed to weather for a period of time in order to determine that the cleaned area will not be adversely affected by wet or freezing weather or by any by-products of the cleaning process.

Repair masonry instead of replacing it. In the case of necessary replacement, new masonry should match existing masonry in color, texture, profile and bond. Brick bonds should not be mixed.

Masonry that has not been previously painted should not be painted. Masonry walls may be painted if extensive repairs have led to a patchwork of masonry surfaces and mismatched mortar.

Water sealants on brick are not generally recommended. Applying waterproofing, water-repellents, or non-historic coatings, such as stucco to a masonry surface as a substitute for repointing and masonry repairs is not recommended. These coatings are frequently unnecessary, expensive and may change the appearance of historic masonry as well as accelerate its deterioration.

Do not construct new masonry features that are either falsely historical (characteristic of a period prior to the building's actual date of construction) or are incompatible with the building or historic district in terms of size, scale, material, or color.

Mortar used to repoint masonry walls should match the original in composition and appearance. New joints should be raked to match the original profile. Mortar should not extend to cover any part of the brick or masonry surface.

For masonry repointing, the original tooling configuration, joint width and depth, and mortar color should be maintained as closely as possible.

Mortar joints

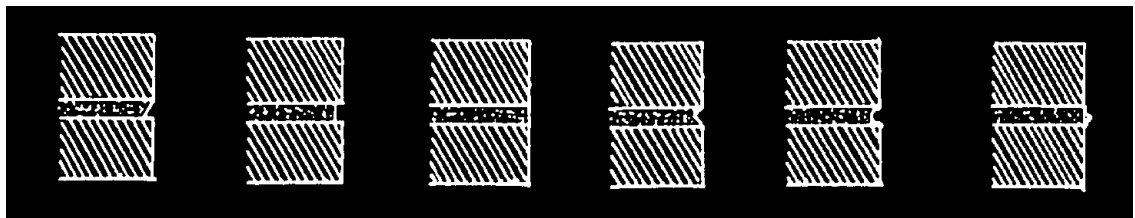

struck

raked

flush

vee

concave

beaded

Masonry: continued

When replacing a section of brick wall, match the existing bonding pattern, coursing, color, size, strength and pointing mortar. Bricks should always be toothed-in to historic brickwork, to disguise the joint between new and old. Make sure exterior replacement bricks are suitable for exterior use.

Photographically documenting architectural features that are slated for reconstruction prior to the removal of any historic fabric is required.

Repoint only those joints that are no longer sound. Do not remove all joints, sound and unsound, in an effort to achieve a uniform appearance when repointing.

Remove unsound mortar joints carefully with hand tools that are narrower than the mortar joint. Power tools should not be used, because they have the potential to scar adjacent masonry.

Mortar composition should allow brick to expand and contract

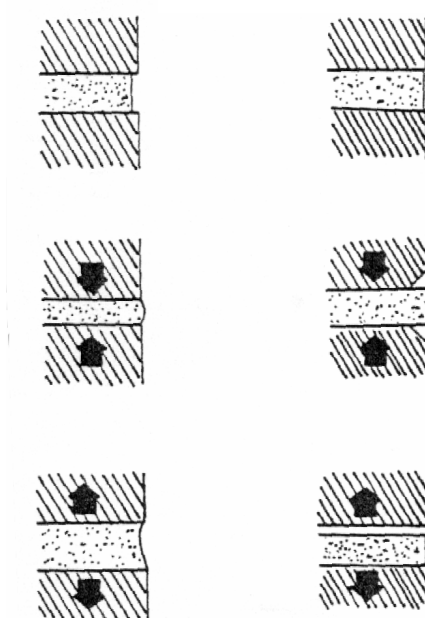

Mortar that is too hard causes cracking and spalling

Foundation walls:

Original brick and stone foundations should not be altered or concealed. It is inappropriate to cover a foundation with a new stone or brick veneer, rolled asphalt, or a stamped metal screen.

Foundations of poured concrete or hollow core concrete blocks should be retained and preserved.

Concrete foundations should be painted or stuccoed.

Roofs:

Original roofing elements should be maintained wherever possible, since they help define a building's historic character. Roof elements include the shape, decorative features, and original sheathing materials as closely as possible.

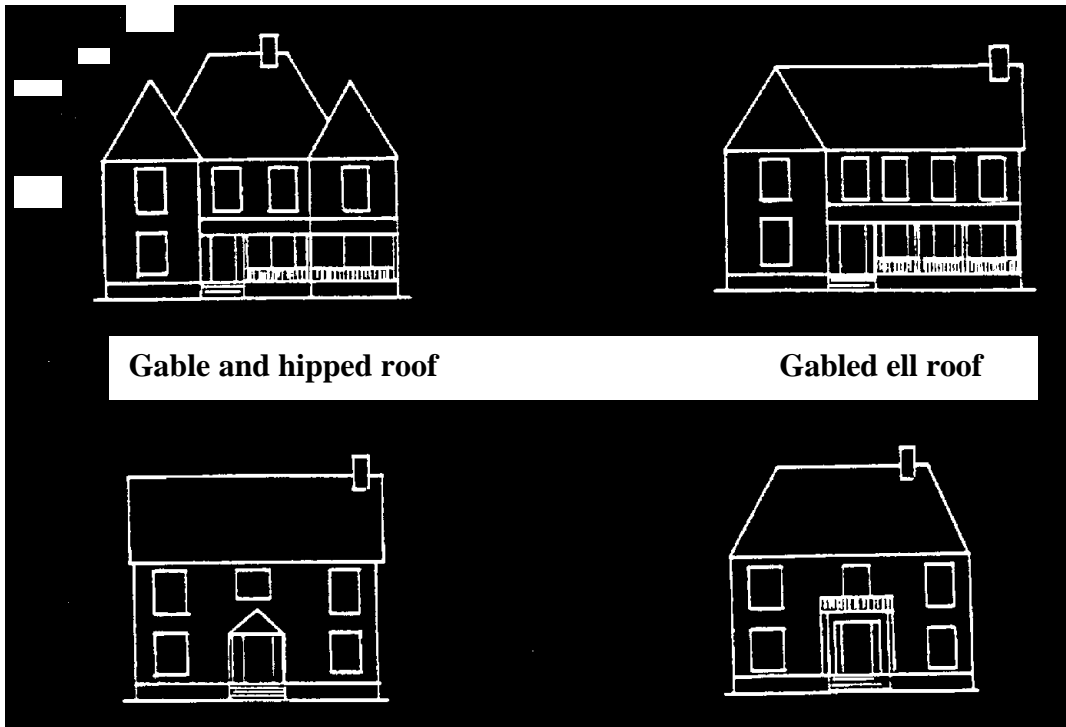

Gable and hipped roof

Gabled ell roof

Side gable roof

Hipped roof



Flat roof

Gambrel roof

Mansard roof

Roof types

Roofs: continued

Original roof materials should be preserved.

Repair deteriorated sections of historic roofing material whenever possible through selective replacement rather than undertaking complete roof replacement.

Replace historic roofing with in-kind materials whenever possible. Substitute materials should be visually, physically, and chemically compatible with the remaining historic roof material and should be installed only when in-kind replacement is technically or economically infeasible.

Decorative ornamentation like finials and balustrades should not be altered or removed.

Asphalt or composition shingle roofs that were added after 1940 may be replaced with similar materials.

Wood shingled roofs may be re-roofed with replacement wood shingles that match the existing. Roofs that were never wood shingled should not be re-roofed with wood shingles.

Base the reconstruction of any missing roof feature on historical, pictorial, and physical evidence. If such evidence is insufficient, the feature should be a compatible new design rather than a falsely historical or conjectural reconstruction.

Leave historically exposed rafter ends and eaves open and uncovered.

Attaching antennae, electrical devices, satellite transmitters, skylights, vents, air conditioning units, decks, terraces, dormers, or solar panels that can be seen from a building's primary elevation is not recommended.

Paint all roof vent assemblies to match the color of the roofing material.

Replace historic roof details, such as decorative cresting and finials and tile ridge caps on tile roofs with in-kind materials or materials that are visually compatible.

Original dormers and their decorative elements should be preserved and maintained.

The addition of new dormers or gables is discouraged. However, dormers and gables may be added if they are in proportion to the building and are on a secondary façade, not readily visible from the street or sidewalk.

Original roofs should not be raised to allow for additional stories.

Skylights may also be added to rear roof slopes if they are not readily visible from the street. Flush or flat skylights are preferred over raised or bubble lights.

Gutters and Downspouts:

Concealed or box gutters should be preserved and repaired whenever possible. If concealed gutters cannot be repaired feasibly, they should be sealed and covered to match the existing roof and replaced with a hanging gutter as necessary.

Exposed gutters or downspouts should be painted to match the trim color. To prevent paint from peeling, new metal should be thoroughly cleaned and painted with galvanized steel primer before applying finish coats of paint.

Where hanging gutters and downspouts are required, the half round type is appropriate.

Chimneys:

Preserve and maintain original chimneys.

Exterior masonry chimneys should not be removed.

Repair and repointing of brick chimneys should be done with brick and mortar that match the original.

If a chimney is in poor condition or has been extensively patched and repointed, it is acceptable to cover the exterior surface with stucco. Stucco should only be used where a chimney's appearance detracts from the appearance of the building.

Decorative brick corbelling and clay chimney caps should not be removed.

Clay, slate or stone chimney caps are preferable to metal chimney caps. Chimney caps are often used to deter sparks from roofs and act as a barrier against rain and small animals.

Removal of brick chimneys or the replacement of chimneys with metal or other materials is not recommended.

Architectural Ornamentation:

Ornamentation which should be maintained and preserved includes brackets, braces, dentils, cornices, molding, and decorative siding that often appears in gabled ends.

Elements that are deteriorated should be repaired or replaced if necessary with materials and profiles to match the original.

Architectural ornamentation that is not based on photographic or physical evidence should not be added. The addition of such ornamentation would not be accurate and would create a misleading appearance not in accordance with the original design and style.

Signage:

In reviewing applications involving signs, the Commission shall use guidelines it has prepared that have been approved by the City Council and the requirements of the Zoning Ordinance. Owner and tenants shall apply to the Commission before their signs are made.

The number, size, height, appearance and location of signs in the Local Historic District shall be controlled by the Historic Preservation Commission through their regular review process.

Any sign not previously approved by the Commission will be considered non-conforming as of the adoption of these Design Guidelines until found to be appropriate by subsequent action of the Commission.

Definitions:

- A. For the purposes of these Design Guidelines, the definitions of signs are hereby defined. All other words and phrases shall be given their common, ordinary meaning unless the context clearly required otherwise.
1. Sign: An identification, description, illustration or device which is affixed to or represented directly or indirectly on a building, structure, or land and which directs attention to a product, place, activity, institution, or business.
 2. Awning Sign: A sign painted on or printed on, or attached against, the surface of an awning.
 3. Mobile or Portable Sign: Any sign which is affixed to a frame having wheels or capable of being carried, or otherwise portable, does not have a permanent foundation, cannot withstand stress and wind loads, and are designed to stand free from a building or other structure.
 4. Temporary Sign: Such as signs supporting the candidacy for office or urging action on any other matter on the ballot of the state, local or national election or referendum, sports events, yard sales, civic organizations, social events, etc.
 5. Sandwich Board Sign: A free standing sign constructed of wood containing no plastic attachments.
 6. Shingle: A sign constructed of wood or metal structurally attached perpendicular to the face of a building.
 7. Wall signs: Any sign affixed in such a way that its exposed face and sign area is parallel to the plane of the building to which it is attached.
 8. Window Signs: Signs painted on or attached to, or suspended behind any window or door that serves as an identification of a business.

Special Sign Regulations:

- A. Signs in the Historic District shall conform to the following regulations:
 - 1. Size: A total sign area of one square foot for each lineal foot of building frontage.
 - 2. Location:
 - a. Signs may be flat wall signs and located on the surface of the building.
 - b. Signs on the vertical faces of canopies may project below the lower edge of the marquee not more than twelve (12) inches. The bottom of shingle and canopy signs shall be no less than eight (8) feet above the sidewalk or grade at any point. No part of a sign shall project above a vertical canopy face.
 - c. Signs shall not project above the roof line, nor cover any window or door opening.

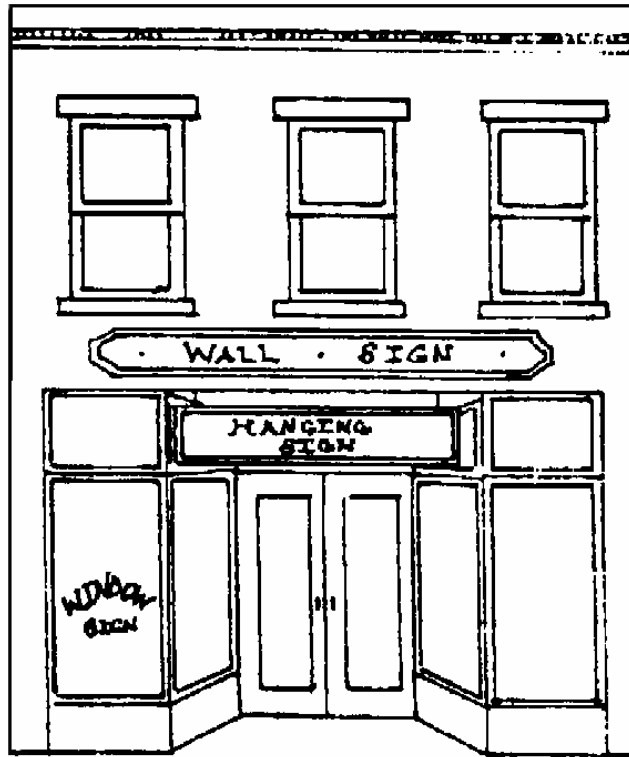

Appropriate sign locations

Special Sign Regulations: continued

3. Guidelines:

- a. Signs and lettering styles should be designed to be historically appropriate and should not predate the facade to which they are applied. (For example, an early 1900's sign should not have a reproduction of a colonial or 1700's sign).
- b. Numbers of colors shall not be restricted; however, color selection should compliment but not necessarily match the building.

4. Illumination:

Illumination of signs is permitted in accordance with the following restrictions:

- a. Lighting should be designed to be historically appropriate.
- b. The light from any illuminated sign shall be so shaded, shielded or directed that light intensity or brightness will not be objectionable to surrounding areas.
- c. No sign shall have blinking, flashing or fluttering lights or other illuminating devices that change light intensity, brightness or color. Beacon lights are not permitted.
- d. No colored lights shall be used at any location or in any manner so to be confused with or construed as traffic control devices.

5. Materials:

- a. Inappropriate materials and finishes generally include, but are not limited to grade wood, unfaced plywood, plastic substrates, and unfinished wood.
- b. Sign brackets shall be constructed of painted wood or pre-finished, or painted metal. Guywires, if needed, shall be as inconspicuous as possible.
- c. Signs shall be mounted in such a way as to minimize damage to historic materials. For example, bolts should extend through mortar joints and not through masonry units.

6. General Criteria:

- a. Signs should not obscure architectural details. Space on the building facade specifically designed to contain signage shall be the most appropriate location for signs.
- b. Retain historic signs and advertising painted on the sides of buildings.
- c. The sign colors should accent and/or harmonize with the color of the building. The style of lettering should be compatible with the building as well as the business. The sign should be in proportion to the building and the letter size in proportion to the sign.
- d. Signs on the angled or curved face are not permitted. Logo and text elements of a sign for awnings may be either silk screened or appliqued stitched.

Non-Conforming Signs:

Signs existing at the same time of enactment as these Design Guidelines, that are not conforming to its provisions but which were constructed in compliance with previous regulations, shall be regarded as non-conforming but may continue to be used if properly repaired and maintained as provided in these Design Guidelines. If thus repaired and maintained the signs shall continue in conformance with other Ordinances of this municipality. However, if repair and maintenance is not maintained, then they shall be considered to be unlocked from this grandfather clause and they shall be removed by the owner, agent, or persons having beneficial use of the structure or land on which the signs are located.

Any sign existing in violation of these regulations, after a violation or the repair and maintenance grandfather clause, shall be removed within six (6) months after the date of passage of these Design Guidelines or from the date of construction, whichever is later.

Non-conforming signs which are structurally altered, relocated, or replaced shall comply immediately with all provisions of this article.

Prohibited Signs:

- A. Prohibited signs are those which:
1. Contain statements, words or pictures of an obscene, indecent, or immoral character, such as will offend public morals or decency.
 2. Contain or are an imitation of an official traffic sign or signal or contain the words "stop", "go slow", "caution", "danger", "warning", or similar words.
 3. Are of a size, location, movement, content, coloring, or manner of illumination which may be confused or construed as a traffic control device or which hide from view any traffic or street sign or signal.
 4. Advertising an activity, business product or service no longer conducted on the premises upon which the sign is located, unless permitted by the Commission.
 5. Contain or consist of banners, posters, pennants, ribbons, streamers, strings of lights, bulbs, spinners, or other similarly moving devices. These devices when not a part of any sign are prohibited, unless they are permitted by the Commission.
 6. May swing or otherwise noticeably move as a result of wind pressure because of the manner of their suspension or attachment, or are not securely fastened to their supports.
 7. Advertise a national or local brand product as part of the overall sign unless approved by the Commission.

Exemptions:

- A. The following types of signs are exempt from all the provisions of these Design Guidelines, except for construction and safety regulations and the following requirements:
1. Public Signs: Signs of a non-commercial nature and in the public interest, erected by, or on the order of, a public officer in the performance of his public duty, such as safety signs, trespassing signs, traffic signs, memorial plaque signs, and signs of historical interest.
 2. Holiday lights and decorations with no commercial message.
 3. Traffic control signs on private property, such as Stop, Yield, and similar signs, and which contain no commercial message.
 4. Temporary signs on the public right-of-way announcing or relating to a campaign, drive or event of a civic, philanthropic, educational, or religious organization are allowed provided that an encroachment permit is obtained from the City of Glasgow or the Barren County Fiscal Court for signs located in the City of Glasgow or Barren County property. These signs shall be removed promptly upon the conclusion of the event to which they relate no later than thirty (30) days.
 5. Signs within a ballpark, field or diamond that indicate sponsorship of the teams or activities that occur therein are allowed.
 6. Small signs such as window signs, rental signs, room and board signs, apartment or house for rent not exceeding four square feet in area.
 7. Vehicles. Signs on vehicles of any kind, provided the sign is painted or attached directly to the body of the original vehicle and does not project or extend beyond the original manufactured body proper of the vehicle.

Murals:

For the purpose of these Design Guidelines murals shall be deemed "Conforming" under the following conditions:

The applicant shall obtain permission from the property owner prior to submission of appropriate artist's drawing before the Commission permits a mural project to proceed.

The Commission shall, after obtaining permission of the property owner, determine the feasibility of wall repairs on the exterior and examine its condition.

A small drawing, photograph or sketch of the mural, along with the size and materials to be used, must be presented to the Commission and the property owner for their review and approval.

Extensive study for the appropriateness of any mural must be made prior to the recommendations for approval, approval with changes or disapproval.

Murals: continued

The mural must be painted directly on an exterior wall or ceiling. No photographic murals are permitted without the approval of the Commission.

The character and value of the mural as defining a reminder of the cultural or architectural heritage of the City shall be paramount when making the decision.

NEW CONSTRUCTION:

New development in the proposed district should take into consideration the existing pattern of the district. The pattern should be imitated whenever possible to reinforce the identity of the district. Building elements making a strong statement in scale may cause severe contrast with their surroundings and aesthetically impair the character of the area and therefore are discouraged.

Siting the building: the orientation of the building on the site should closely relate to those adjacent properties. The massing of the structure should not overpower those already in existence since their prominence has been historically documented and have acquired significance in their own right. The scale of the structure should be considered since it should not oppose but be sympathetic with its neighbors.

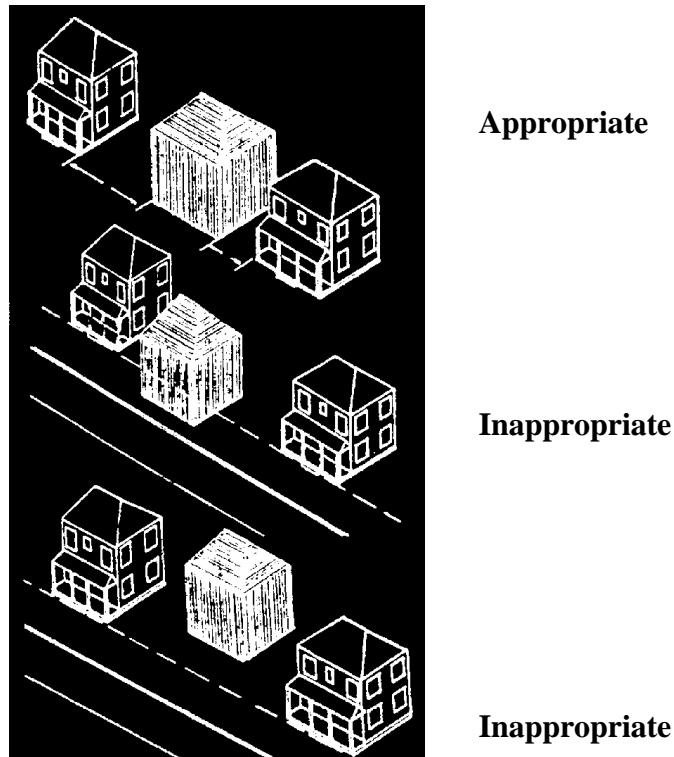

Building setbacks should be maintained

Front facades of new buildings should face toward the street. Buildings located in corner lots may have entrances to the side streets.

Existing buildings contributing to the architectural character of the district should be preserved.

The roof shape is not limited, however, the proposed roof form should respect the profile typical of the area and not be the primary focus of the building.

NEW CONSTRUCTION: continued

New roofs should be compatible with existing roofs in shape and materials.

The architectural style is not restricted. Buildings will be evaluated based on their appearance, quality of design and relationship to the surrounding environment.

Any exterior renovation or new construction should be compatible with the architectural design period typically found in the district.

New infill construction should be designed so that it is compatible with adjacent buildings in height, scale, materials, massing, orientation, setback, facade organization and roof form.

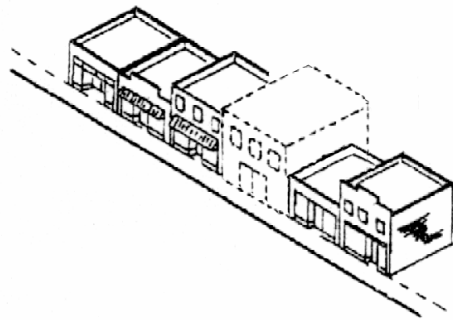

Appropriate infill

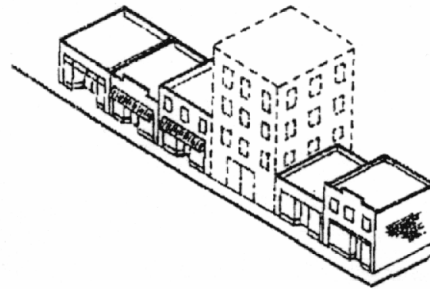

Inappropriate infill



Existing building

Compatible new design

NEW CONSTRUCTION: continued

Window and door openings of proposed buildings should reflect the existing scale typical of the district.

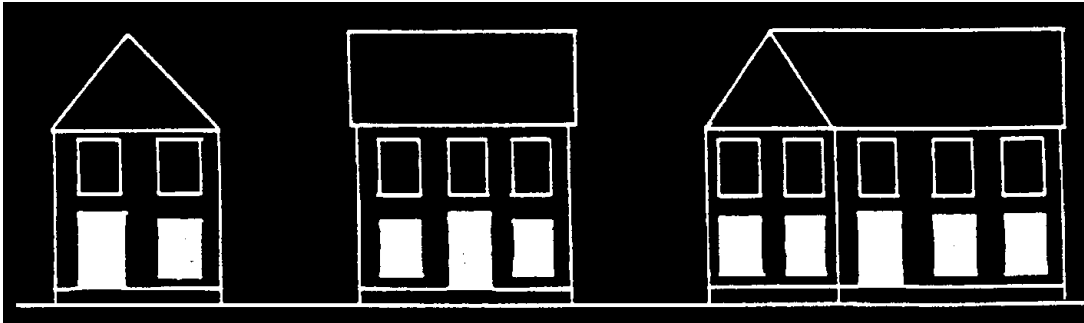

Appropriate scale and rhythm of door and window openings

New construction and additions should also draw upon established stylistic elements to create a sympathetic design that is clearly of its own era.

New additions should be designed to minimize the impact to the existing historic fabric and should be compatible with the primary building in massing, size and scale.

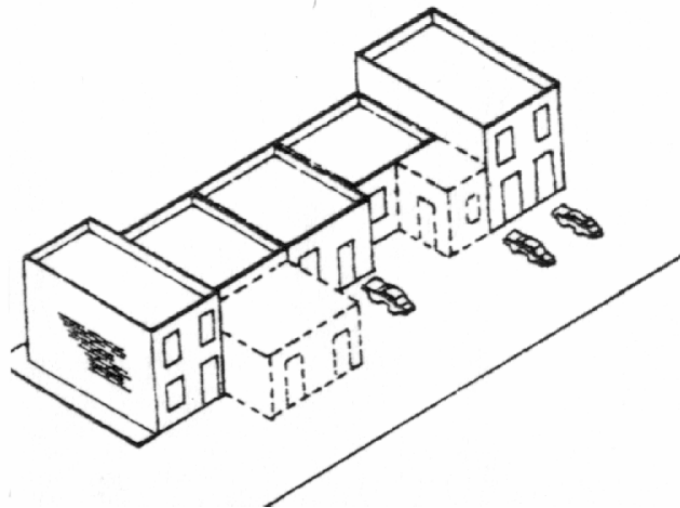

Appropriate rear addition

NEW CONSTRUCTION: continued

Additions that use new or salvaged material to create a conjectural or falsely historic appearance are inappropriate.

Porches on new residences should maintain the rhythm and placement of porches of adjacent historic structures along a block.

Historic buildings, which have been clearly documented through original floor plans, drawings or photographs, may be reconstructed on the original site.

Reconstructed buildings should be constructed with materials, details and decorative features to match or closely approximate the original building.

Reconstructed buildings must be clearly designated so as not to misrepresent them as being historic.

DEMOLITION AND RELOCATION:

A building or structure in an historic district should not be moved or relocated outside the district if the building or structure is to retain its architectural and historical integrity.

A building or structure that does not contribute to the architectural and historical character of a district may be moved or relocated if its removal would result in a more positive visual appearance in the district.

Historic buildings within a district should not be moved from one site to another except where threatened with demolition or loss of integrity of site and setting.

Buildings that are moved to another location in the district should be compatible with adjacent buildings in style, height, scale, materials and setback and should be similar in site and setting.

A building may be moved into a district if it is architecturally compatible with adjacent structures on its new site. The new building must maintain and uphold the district's architectural character through its style, height, scale, massing, materials, texture, site and setting.

In considering an application for demolition of a building, site, structure or object, the following shall be considered: the historic and/or architectural significance of the building; the importance of the building to the overall ensemble of the buildings within the district; the special character and aesthetic interest that the building adds to the district; the difficulty or impossibility of reproducing such a building because of its design, texture, material or detail; and the future utilization of the site.

Demolition may be approved if public safety and welfare requires removal or where economic hardship has been demonstrated, proven and accepted by the Commissioners.

Demolition may be approved if a structural engineer or architect has demonstrated the structural instability or deterioration through a report. The report must clearly detail the property's physical condition, reasons why rehabilitation is not feasible, and cost estimates for rehabilitation versus demolition. In addition to this report there should be a separate report that details future action on the site.

Demolition may be approved where buildings have lost their original architectural integrity and no longer contributes to the character of a district.

DEFINITIONS:

Procedural Definitions:

Certificate of Appropriateness - A document awarded by a preservation commission allowing an applicant to proceed with a proposed alteration, demolition, or new construction in a designated area or site, following a determination of the proposal's suitability according to applicable criteria.

Certified Local Government - any city, county, parish, township, municipality, or borough, or any other general purpose subdivision which may participate in the activities outlined in the National Preservation Act Amendments of 1980 to further delegate responsibilities and funding to the local level.

Due Process - The established procedure by which legal action is carried out.

Normally Required - Mandatory actions, summarized in the guidelines, whose compliance is enforced by the Commission.

Public Notice - The classified advertisement of an event, such as a Commission meeting, that is published in the local newspaper and posted in the city government building in order to notify the general public of the upcoming event.

Recommended - Suggested, but not mandatory actions summarized in the guidelines.

Technical Definitions:

Addition - New construction added to an existing building or structure.

Alteration - Work which impacts any exterior architectural feature including construction, reconstruction, repair, or removal of any building element.

Appropriate - specially suitable or compatible.

Building - A structure used to house human activity such as a dwelling or garage.

Character - The qualities and attributes of any structure, site, street, or district.

Commission - The Glasgow Historic Preservation Commission

Committee – The Glasgow Historic Preservation Commission's Design Review Committee

Configuration - The arrangement of elements and details on a building or structure which help to define its character.

Technical Definitions: continued

Contemporary - Reflecting characteristics of the current period. Contemporary denotes characteristic which illustrate that a buildings, structure, or detail was constructed in the present or recent past rather than being imitative or reflective of a historic design.

Compatible - In harmony with location and surroundings.

Context - The setting on which a historic element, site, structure, street or district exists.

Demolition - Any act which destroys in whole or in part a building or structure.

Demolition by Neglect - The destruction of a building or structure through abandonment or lack of maintenance.

Design Guidelines - Criteria developed by the Local Historic Preservation Commission's Design Review Committee and the general public to identify design concerns in an area and to help property owners ensure that rehabilitation and new construction respect the character of designate buildings and districts.

Element - A material part or detail of a site, structure, street, or district.

Elevation - Any one of the external faces or facades of a building.

Fabric - The physical material of a building, structure or community connoting an interweaving of component parts.

Harmony - Pleasing or congruent arrangement.

Height - The distance from the bottom to the top of a building or structure.

Historic District - A geographically definable area with significant concentration of buildings, structures, sites, spaces or objects unified by past events, physical development, design, setting, materials, workmanship, sense of cohesiveness or related historical and aesthetic associations. The significance of district may be recognized through listing in a local, state, or national landmarks register and may be protected legally through enactment of a local historic district ordinance administered by a historic district board or commission.

Historic Imitation - New construction or rehabilitation where elements or components mimic an architectural style but are not of the same historic period as the existing buildings.

Infill - New construction in historic districts on vacant lots or to replace existing buildings.

Landmark - A building, structure, object or site that is identified as a historic resource of particular significance.

Technical Definitions: continued

Landscape - The totality of the built or human-influenced habitat experienced at any one place. Dominant features are topography, plant cover, buildings, or other structures and their patterns.

Maintain - To keep in an existing state of preservation or repair.

New Construction - Construction which is characterized by the introduction of new elements, sites, buildings, or structures or additions to existing buildings and structures in historic areas and districts.

Obscured - Covered, concealed, or hidden from view.

Preservation - Generally, saving from destruction or deterioration old and historic buildings, sites, structures, and objects and providing for their continued use by means of restoration, rehabilitation, or adaptive use.

Proportion - Harmonious relation of parts to one another or to the whole.

Recommendation - An action or activity advised but not required by the Commission.

Reconstruction - The act or process of reproducing by new construction the exact form and detail of a vanished building, structure, or object, or a part thereof, as it appeared as at specific period of time.

Rehabilitation - The act or process of returning a property or building to usable condition through repair, alteration, and/or preservation of its features which are significant to its historical, architectural and cultural values.

Restoration - The act or process of accurately taking a building's appearance back to a specific period of time by removing later work and by replacing missing earlier features to match the original.

Retain - To keep secure and intact. In the guidelines, "retain" and "maintain" describe the act of keeping an element, detail or structure and continuing the same level of repair to aid in the preservation of elements, sites and structures.

Re-use - To use again. An element, detail, or structure might be reused in historic districts.

Rhythm - Movement or fluctuation marked by the regular occurrence or natural flow of related elements.

Scale - Proportional elements that demonstrate the size, materials, and style of buildings.

Setting - The sum of attributes of a locality, neighborhood, or property that defines its character.

Technical Definitions: continued

Significant - Having particularly important associations within the contexts of architecture, history and culture.

Stabilization - The act or process of applying measures essential to the maintenance of a deteriorated building as it exists at present, establishing structural stability and a weather resistant enclosure.

Streetscape - The distinguishing character of a particular street created by its width, degree of curvature, paving materials, design of the street furniture, and forms of surrounding buildings.

Style - A type of architecture distinguished by special characteristics of structure and ornament and often related in time; also a general quality of a distinctive character.

Architectural Definitions:

Appurtenance - Any built-in, nonstructural portion of a building, such as doors, windows, ventilators, electrical equipment, partitions, etc.

Apron - A decorative, horizontal trim piece on the lower portion of an architectural element.

Arch - A curved construction of wedge-shaped stones or bricks that spans an opening and supports the weight above it. See flat arch, jack arch, segmental arch and semi-circular arch.

Architrave - The lowest section of the entablature that rests on the capital of a column. It also refers to the decorative molding around a door or window.

Attic - The upper level of a building, not of full ceiling height, directly beneath the roof.

Baluster - One of a series of short, vertical, often vase-shaped members used to support a stair or porch handrail, forming a balustrade.

Balustrade - An entire rail system with top rail and balusters.

Bargeboard - A board which hangs from the projecting end of a gabled roof, covering the end rafters and often sawn into a decorative pattern. Also called a vergeboard.

Battered - Having sloped sides, in reference to piers and columns in the bungalow style.

Bay - The portion of a facade between columns or piers providing regular divisions and usually marked by windows.

Bay Window - A projecting window that forms an extension to the floor space of the internal rooms; usually extends to the ground level.

Architectural Definitions: continued

Belt Course - A horizontal band usually marking the floor levels on the exterior facade of a building.

Board and Batten - Siding fashioned of boards set vertically and covered where their edges join by narrow strips called battens.

Bond - A term used to describe the various patterns in which brick or stone is laid, such as "common bond" or "Flemish bond."

Brace - An essential structural member placed diagonally as a support between horizontal and vertical surfaces, as under the eaves of a roof.

Bracket - A projecting element of wood, stone, or metal which spans between horizontal and vertical surfaces such as eaves, shelves, overhangs, as a decorative support.

Canopy - A projecting awning suspended above an opening.

Capital - The head of a column or pilaster.

Casement Window - A window with one or two sashes which are hinged at the sides and usually open outward.

Clapboards - Horizontal wooden boards, thinner at the top edge, that are overlapped to provide a weatherproof exterior wall surface.

Classical Order - Derived from Greek and Roman architecture, a column with its base, shaft, capital and entablature having standardized details and proportions, according to one of the five canonized modes: Doric, Tuscan, Ionic, Corinthian, or Composite.

Clipped gable - A gable roof where the ends of the ridge are terminated in a small, diagonal roof surface.

Column - A circular or square vertical structural member.

Common bond - A brickwork pattern where most courses are laid flat, with the long "stretcher" edge exposed, but every fifth to eighth course is laid perpendicularly with the small "header" end exposed, to structurally tie the wall together.

Corbel - In masonry, a projection, or one of a series of projections, each stepped progressively farther forward with height and articulating a cornice or supporting an overhanging member.

Corinthian order - Most ornate classical order characterized by a capital with ornamental acanthus leaves and curled fern shoots.

Architectural Definitions: continued

Cornice - The uppermost, projecting part of an entablature, or feature resembling it. Any projecting ornamental molding along the top of a wall, building, etc.

Cresting - A decorative ornamental finish along the top of a wall or roof, often made of ornamental metal.

Cross-gable - A secondary gable roof which meets the primary roof at right angles.

Cupola - A dome shaped roof set on a circular base, often set on the ridge of a roof.

Dentils - A row of small tooth-like blocks in a classical cornice.

Doric order - A classical order with simple, unadorned capitals and with no base.

Dormer - A small window with its own roof that projects from a sloping roof.

Dormer window - A window that projects from a roof.

Double-hung window - A window with two sashes, one sliding vertically over the other.

Drivit - A built up plaster finish resembling stucco.

Eave - The edge of a roof that projects beyond the face of a wall.

Elevation - Any of the external faces of a building.

Ell - The rear wing of a house, generally one room wide and running perpendicular to the principal building.

Engaged column - A round column attached to a wall.

Entablature - A part of a building of classical order resting on the column capital; consists of an architrave, frieze, and cornice.

Facade - A face or front elevation of a building.

Fanlight - A semi-circular window usually over a door with radiating maintains suggesting a fan.

Fascia - A projecting flat horizontal member or molding: forms the trim of a flat roof or a pitched roof; also part of a classical entablature.

Fenestration - The arrangement of windows on a building.

Architectural Definitions: continued

Finial - An ornament which terminates the point of a spire, pinnacle. A projecting decorative element, usually of metal, at the top of a roof turret or gable.

Fishscale shingles - A decorative pattern of wall shingles composed of staggered horizontal rows of wooden shingles with half-round ends.

Flashing - Thin metal sheets used to prevent moisture infiltration at joints of roof planes and between the roof and vertical surfaces.

Flat arch - An arch whose wedge shaped stones or bricks are set in a straight horizontal line; also called a jack arch.

Flemish bond - A brick-work pattern where the long "stretcher" edge of the brick is alternated with the small "header" end for decorative as well as structural effectiveness.

Fluting - Shallow, concave grooves running vertically on the shaft of a column, pilaster, or other surface.

Foundation - The lowest portion of the building that supports the structure above.

Fretwork - Ornamental woodwork, cut into a pattern, often elaborate.

Frieze - The middle portion of a classical cornice; also applied decorative elements on an entablature or parapet wall.

Frieze Board - Flat board at top of wall directly beneath the cornice.

Gable - The triangular section of a wall to carry a pitched roof.

Gable roof - A pitched roof with one downward slope on either side of a central, horizontal ridge.

Gambrel roof - A ridged roof with two symmetrical slopes on either side.

Gingerbread - Pierced curvilinear ornament made with a jig or scroll saw.

HVAC - Heating, ventilation, and air conditioning.

Hipped roof - A roof with uniform slopes on all sides. (All eaves are at the same level).

Hood molding - A projecting molding above an arch, doorway, or window, originally designed to direct water away from the opening; also called a drip mold.

Ionic order - One of the five classical orders used to describe decorative scroll capitals.

Architectural Definitions: continued

Infill - New construction where there had been an opening space before, such as a new building between two older structures; or block infill between porch piers or in an original window opening.

Jack arch - (See Flat arch)

Light - A section of a window, the pane of glass.

Keystone - The wedge-shaped top or center member of an arch.

Kneebrace - An oversized bracket supporting a cantilever or projecting element.

Lattice - An openwork grill of interlacing wood strips used as screening.

Lintel - The horizontal top member of a window, door, or other opening.

Mansard roof - A roof with a double slope on all four sides, with the lower slope being almost vertical and the upper almost horizontal.

Marquee - A permanent roof-like shelter over an entrance to a building.

Masonry - Exterior wall construction of brick, stone or adobe laid up in small units.

Massing - The three-dimensional form of a building.

Metal standing seam roof - A roof composed of overlapping sections of metal such as copper-bearing steel or iron coated with terne alloy of lead and tin. These roofs were attached or crimped together in various raised seams for which the roof is named.

Modillion - A bracket projecting outward horizontally, often in the form of a plain block, ornamenting, or sometimes supporting, the underside of a cornice.

Mortar - A mixture of sand, lime, cement and water used as a binding agent in masonry construction.

Multi-light window - A window sash composed of more than one pane of glass.

Muntin - A secondary framing member to divide and hold the panes of glass in multi-light window or glazed door.

Neo-classical style - Early twentieth century style which combines features of ancient, Renaissance, and Colonial architecture; characterized by imposing buildings with large columned porches.

Architectural Definitions: continued

Oriel window - A bay window that emerges above the ground floor level.

Outbuilding - A building subsidiary to, but separate from, a main house or building.

Paired columns - Two columns supported by one pier, as on the porch.

Palladian window - A window with three openings, the central one arched and wider than the flanking ones.

Panelled door - A door composed of solid panels (either raised or recessed) held within a framework of rails and stiles.

Parapet - A low horizontal wall at the edge of a flat roof.

Pediment - A triangular crowning element forming the gable of a roof; any similar triangular element used over windows, doors, etc.

Pier - A vertical structural element, square or rectangular in cross-section.

Pilaster - A square pillar attached, but projecting from a wall, resembling a classical column.

Pitch - The degree of the slope of a roof.

Porte-cochere - A porch large enough to extend over a driveway.

Portico - A roofed space, open or partly enclosed, forming the entrance and centerpiece of the facade of a building, often with columns and a pediment.

Portland cement - A strong inflexible cement used to bind mortar. (Mortar or patching materials with a high Portland cement content should not be used on old buildings. The Portland cement is harder than the masonry, thereby causing serious damage over annual freeze-thaw cycles).

Pressed tin - Decorative and functional metalwork made of molded tin used to sheath roofs, bays, and cornices.

Pyramidal roof - A roof with four identical sides rising to a central peak.

Quoins - Larger stones which mark the corner of a building of brick or stone.

Rafter end - The part of the rafter that overhangs the wall.

Ridge - The top horizontal member of a roof where the sloping surfaces meet.

Ridgecap - Any covering used to cover the ridge of a roof.

Architectural Definitions: continued

Rusticated Masonry - Roughened stonework or concrete block to give greater articulation to each block.

Sailor course - A row of horizontal brick headers used as a lintel, sill, or as a belt course.

Sandblast - To use sand, propelled by an air blast, on metal, masonry, concrete, etc. to remove dirt, rust or paint, or to decorate the surface with a rough texture.

Sash - The moveable framework containing the glass in a window.

Semi-circular arch - An arch whose profile or radius is a half-circle the diameter of which equals the opening width.

Sheathing - An exterior covering of boards or other surface applied to the frame of the structure. (see Siding).

Shed roof - A gently-pitched, almost flat roof with only one slope.

Sidelight - A vertical area of fixed glass on either side of a door or window.

Siding - The exterior wall covering or sheathing of a structure.

Sill - The bottom crosspiece of a window frame.

Soldier course - A row of vertical brick headers used as a lintel, sill or belt course.

Spalling - Loss of fragments such as: stone, metal, concrete, glass, or a ceramic product, from a face or edge due to weathering.

Spindles - Slender, elaborately turned wood dowels or rods often used in screens and porch trim.

Stack bond - Stack bond in brickwork, a bond in which the facing brick is laid with all vertical joints continuously aligned. In stone veneer masonry, a pattern in which units of a single size are set with continuous vertical and horizontal joints.

Streetscape - The overall facade, not of a single structure, but of the many buildings that define the street.

Surround - An encircling border or decorative frame, usually at windows or doors.

Swag - Carved ornamentation in the form of a cloth draped over supports, or in the form of a garland of fruits and flowers.

Architectural Definitions: continued

Terra Cotta - Cast and fired clay units, used as ornamentation and set in the masonry construction of a building.

Transom - A horizontal opening (or window) over a door or window.

Trim - The decorative framing of openings and other features on a facade.

Turret - A small slender tower.

Veneer - A thin sheet of wood that has been sliced, rotary-cut, or sawn from a log: use as one of several plies in plywood for added strength or as a facing material on a less attractive wood. Also, an outside wall facing of brick, stone, etc.: provides a decorative, durable surface but is not loadbearing.

Veranda - A covered porch or balcony on a building's exterior.

Vergeboard - The horizontal face board following and set under the roof edge of a gable, sometimes decorated by carving.

Vernacular - A regional form or adaptation of an architectural style.

Wall dormer - Dormer created by the upward extension of a wall and a breaking of the roofline.

Water table - A projecting horizontal ledge, intended to prevent water from running down the face of a wall's lower section.

Weatherboard - Wood siding consisting of overlapping boards usually thicker at the lower edge than the upper edge (clapboard).

**APPENDIX A:
SUGGESTED BIBLIOGRAPHY**

SUGGESTED BIBLIOGRAPHY

- Blumenson, John J.G. Identifying American Architecture. Nashville: American Association for State and Local History, 1981.
- Browne, Dan. The Renovation Book. New York: McGraw-Hill, 1976.
- Friedland, Edward P. Antique Houses: Their Construction and Restoration. Garden City, New York: Doubleday, 1981.
- Hanson, Shirley and Nancy Hubby. Preserving and Maintaining the Older Home. New York: McGraw-Hill, 1983.
- Hutchins, Nigel. Restoring Old Houses. New York: Van Nostrand Reinhold, 1980.
- Labine, Clem, ed. Clem Labine's Traditional Building. Brooklyn, New York: Historical Trends Corporation.
- Litchfield, Michael W. Renovation: A Complete Guide. New York: Wiley, 1982.
- London, Mark. Respectful Rehabilitation, Masonry, How To Care For Old And Historic Brick & Stone. Washington, D.C.: The Preservation Press, 1986.
- McAlester, Virginia and Lee McAlester. A Field Guide to American Houses. New York: Alfred A. Knopf, 1984.
- Morton, W. Brown, III, Gary L. Hume, and Kay D. Weeks. The Secretary of the Interior's Standards for Rehabilitation and Guidelines for Rehabilitating Historic Buildings. 1979. Rev. ed. Washington, D.C.: Technical Preservation Services. U.S. Department of the Interior, 1983.
- Nash, George. Old-houses, A Rebuilder's Manual. Englewood Cliffs, N.J.: Prentiss-Hall, 1980.
- Old-House Journal. Monthly. Old-House Journal Corporation, 435 Ninth Street, Brooklyn, New York, 11215.
- Park, Sharon D., AIA. The Use of Substitute Materials on Historic Building Exterior. Preservation Brief no. 16. Washington, D.C.: Technical Preservation Services. U.S. Department of the Interior, 1989.
- Preservation and Conservation: Principle and Practices. Washington, D.C.: The Preservation Press, 1988.
- Preservation Briefs. Published periodically. Washington, D.C.: Government Printing Office.
- Rifkind, Carole. A Field Guide to American Architecture. New York: New American Library, 1980.
- Rooney, William F. Practical Guide to Home Restoration. New York: Bantam/Hudson Idea Books, 1980.
- Rusk, Katherine. Renovating the Victorian House: A Guide for Aficionados of Old Houses. San Francisco: One Hundred One Productions, 1981.
- Stahl, Frederick A. A Guide to the Maintenance, Repair, and Alteration of Historic Buildings. New York: Van Nostrand Reinhold, 1984.
- Stanforth, Deirdre, and Martha Stamm. Buying and Renovating a House in the City: A Practical Guide. New York: Alfred A. Knopf, 1972.
- Stephen, George. New Life for Old House. Washington, D.C.: The Preservation Press, 1989.
- _____. Remodeling Old House Without Destroying Their Character. New York: Alfred A. Knopf, 1973.
- Technical Preservation Services, National Park Service, U.S. Department of the Interior. Respectful Rehabilitation. Washington, D.C.: The Preservation Press, 1982.

SUGGESTED BIBLIOGRAPHY: continued

Weaver, Martin E. Conserving Buildings: A Guide to Techniques and Materials. New York: John Wiley & Sons, Inc., 1993.

Weeks, Kay D. New Exterior Additions to Historic Buildings: Preservation Concerns. Preservation Brief no. 14. Washington, D.C.: Technical Preservation Service, U.S. Department of the Interior, 1986.

**APPENDIX B:
USEFUL WEB SITES**

USEFUL WEB SITES

National Park Service Home Page:

<http://www.nps.gov>

National Park Service Links To The Past:

<http://www.cr.nps.gov>

**National Park Service Heritage
Preservation Services Home Page:**

<http://www2.cr.nps.gov>

The urls of HPS programs and associated sites:

American Battlefield Protection Program:

http://www2.cr.nps.gov/abpp/abpp_t.htm

Battlefield Update:

<http://www2.cr.nps.gov/abpp/latest.htm>

Certified Local Government Program:

http://www2.cr.nps.gov/clg/clg_t.htm

Challenge Cost-Share Program:

http://www2.cr.nps.gov/ccs_p.htm

**Cultural Resources Mapping &
Geographic Information Systems (GIS)**

http://www2.cr.nps.gov/gis/gis_t.htm

Mapping & Preservation Inventory:

<http://www2.cr.nps.gov/gis/mapit.htm>

Cultural Resource Training Initiative:

http://www2.cr.nps.gov/tps/crti/crti_p.htm

**Federal Agency Preservation Assistance
Program:**

http://www2.cr.nps.gov/pad/fapa_p.htm

**Federal Historic Preservation Tax
Incentives:**

http://www2.cr.nps.gov/tps/tax/tax_t.htm

**Historic Preservation Certification
Applications:**

<http://www2.cr.nps.gov/tps/tax/htm>

Tax Act Status:

<http://tps.cr.gov/status>

**General Services Administration
Home Page:**

<http://www.gsa.gov>

**General Services Administration
Specifications:**

<http://www.gsa.gov/pbs/hptp>

<http://w3.gsa.gov/web/p/hptp.nsf?Opendatabase>

NCSHPO Home Page:

<http://sso.org/nscshpo/index.htm>

Historic Landscape Initiative:

http://www2.cr.nps.gov/hlii/hli_t.htm

Historic Preservation Fund Grants:

http://www2.cr.nps.gov/hpf/hpf_t.htm

**Historic Preservation Internship Training
Program:**

http://www2.cr.nps.gov/tps/hpit_p.htm

Historic Preservation Planning Program:

<http://www2.cr.nps.gov/pad/>

Historic Surplus Property Program:

http://www2.cr.nps.gov/tps/h spp_p.htm

**National Historic Landmarks Assistance
Initiative:**

http://www2.cr.nps.gov/nhl/nhl_t.htm

**Technical Preservation Services for
Historic Buildings:**

<http://www2.cr.nps.gov/tps/briefs/presbbhom.htm>

Tribal Preservation Programs:

http://www2.cr.nps.gov/trribaal/tribal_t.htm

Tribal Preservation: grants & Funding:

<http://www2.cr.nps.gov/trribal/grants.html>

THIS PAGE INTENTIONALLY LEFT BLANK